

# DECUSCOPE

DIGITAL EQUIPMENT COMPUTER USERS SOCIETY

January 1966  
Vol. 5 No. 1

## A STEREOSCOPE DISPLAY FOR ON-LINE MONITORING OF SIMULATED TERMINAL ENGAGEMENTS

Psychology Group

M.I.T. Lincoln Laboratory, Lexington , Mass.

This article was extracted from Technical Note 1965-58 prepared by Lincoln Laboratory under Electronic Systems Division Contract AF19 (628)-5167.

It describes a stereoscopic, dynamic display of reentry bodies. A simulation program on an IBM 7094 generates information for the display and feeds it to a PDP-1 computer. The PDP-1 drives a Type 340 CRT display which is viewed through a special device by a systems analyst. The reasons for this project are threefold: it is part of a larger effort to evaluate techniques for on-line control of large computer programs that simulate systems and analyze systems data; it is intended as a test of the feasibility of generating on commercial equipment a display that will give an immediate perception of depth; and the display is to be used in a study of terminal defense doctrine with an existing simulation program.

### Background

A principal objective of Lincoln Laboratory to develop new computer techniques is to replace the present awkward procedures for using computers in the analysis of data and the simulation of systems. At present the analyst is subject to delays of a day to a week in obtaining results from a particular computer run. If he could monitor his program during the run and intervene on-line, he would achieve advantages of speed and efficiency. For example, whenever he perceived the effects of an error of procedure or judgment, he would be able to stop the run, correct the error at once, and begin again. During the run, especially with good on-line displays, he would get an immediate appreciation of the significance of the results. Often the analyst is testing a hypothesis about the nature of his data or the effect of a system parameter. If the results come back while the rationale that led to the hypothesis is still fresh in his mind, his appreciation of the results is likely to be more rapid and profound. For these reasons an on-line facility should provide a marked improvement in efficiency and speed over the present methods

of computer analysis.

Moreover, on-line analysis has a unique advantage: the analyst may become an active participant in the process. When it reaches a given point, the program may display relevant information, relinquish control to the analyst, and wait for orders. It is not difficult to imagine instances in which this kind of facility would be of great value, for example, in the development of new procedures of data analysis or in the invention of new system doctrine.

A breadboard computer and display system for on-line analysis of systems is being prepared to test the validity of these ideas. No prototype equipment or programs are being developed. Rather this is a test facility, assembled largely from existing machinery and programs, where the systems analyst can work on substantive problems on-line with the computer. The essential product of this effort is an understanding of the advantages and costs of on-line procedures. Of course, it is hoped to achieve a useful interim capacity to accelerate progress in selected areas.

A block-diagram of the system for this study is shown in Figure 1. During live operation, calculations are made on the 7094 in Building J at Lincoln Laboratory and sent by wide-band link to the PDP-1 computer in Building L. The current data is shown on the display in the form of a dynamic picture of RV's and interceptors. The operator makes decisions relevant to intercept assignments. His orders are sent back to the 7094 via typewriter, PDP-1, and data-link and cause new interceptor launches in subsequent steps. Efficient use of the 7094 is achieved by dumping the simulation program onto the disc file and making routine calculations of other kinds during the relatively long waits between orders from the analyst at the PDP-1. During the display-development phase reported here, output of the 7094 simulation program was recorded on tape and run off-line at the PDP-1 to test the display techniques. The dotted lines in Figure 1 indicate the tape links between the computers.

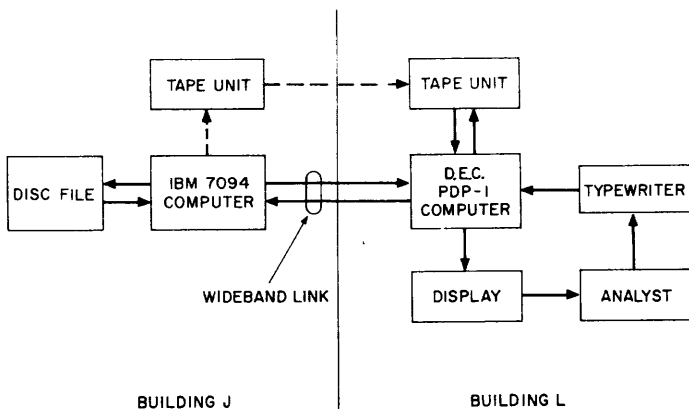

Figure 1 Block Diagram Experimental On-Line System

### The Display

The input to the display consists of two kinds of information: the locations of objects at successive times and a table of interceptor assignments. The position of each object, RV or interceptor, is given in three coordinates of space at 1-second intervals beginning at the time of appearance of the first RV. A table, which is kept up to date second by second, shows the number of the RV to which each interceptor is assigned.

The most difficult display requirement is to achieve a complete picture of an engagement--one that presents objects in three-dimensional space and changes as the engagement progresses. Several techniques were considered. For example, considerable work has been done recently on the use of relative motion as a method for obtaining a perception of depth with a computer-driven display. This method consists of showing the changing two-dimensional projection of a cluster of lines while the cluster is rotating in space. Previous research at Lincoln Laboratory by Green et al\* showed that depth is readily perceived during rotation, even if the cluster is made up of a haphazard arrangement of elements. However, in the case where the elements move with respect to one another, as do RV's and interceptors in a terminal engagement, the change due to rotation is confounded with change of relative position among the objects. Thus, an accurate perception of the position of the objects over time seemed out of the question for this application.

\*Figure coherence in the kinetic depth effect. *J. exp. Psychol.*, 1961, Vol. 62, No. 3, 272-282.

The only reasonable way to achieve depth perception appeared to be to use the time-honored principle of the stereoscope. A separate view was presented to each eye. Appropriate geometrical discrepancies were introduced--discrepancies in keeping with the slightly disparate views of two eyes viewing objects distributed in depth and viewed at short range--about 30 inches. The two views were painted on the CRT in an unusual orientation and were seen through a viewing device.

Looking through the viewer, the analyst sees a side view of the engagement, except that his view includes depth. The

target and the interceptor farms are at the bottom near the left-hand margin. Reentering objects enter at the upper right, and the nominal trajectory to the target is in the frontal plane. The "standard picture," the largest area available to the operator, is about 250 km wide and 120 km high and depth is perceived readily in the range between 50 km in front of the reentry plane and 50 km behind it. The display is quantized, and the unit of quantization (which is set by the logical circuitry that drives the CRT) is 1/4 km in width and height, and 2 km in depth.

There is an X2 expanded view. A selected volume 125 km wide by 60 km high is expanded by a factor of two in each of the three dimensions--width, height, and depth--and fills the entire display. Off-centering of the expanded area is provided in the lateral and vertical dimensions, but not in depth. Expansions of X4 and X8 are also provided. Since the unit of quantization is a fixed distance on the face of the CRT, the quantization error in kilometers decreases by a factor of two in all three dimensions with each factor of two in expansion.

The current (or latest) position of each object is represented by a point, as in Figure 2. Directly below the point, and perceived at the same depth, is a number tag representing the depth of the object in kilometers. (The number "50" is arbitrarily set to represent the depth of the nominal trajectory plane.) Alternatively, the tags may be changed so that they refer to the number of the objects in the simulation program.

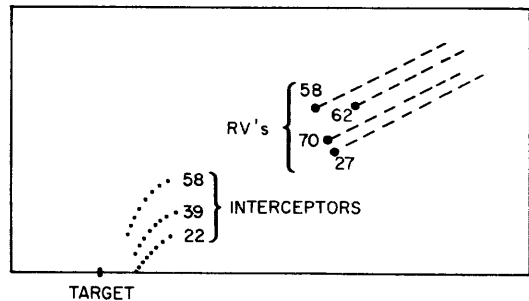

Figure 2 Analyst's View of Reentry Events

The dynamics of the engagement are presented by showing the analyst 8 seconds of history for each object. The RV trails are dashes; the length of the dash is proportional to depth--the longer dashes indicating closer objects. Interceptor trails are represented by a series of dots. Current position and the number tag are bright and steady, but the trails of interceptor dots and RV dashes are presented in rapid sequence. The timing is such that there are repeated cycles of apparent movement along the trail up to the current position. If the analyst wants to review an earlier portion of the engagement, i.e. back up in time, he may temporarily designate any earlier second as "current time." He will then see the positions of the objects at that time, with the usual 8 seconds of history behind them.

A maximum of 32 RV's and 32 interceptors may be shown. With that many objects on the display, the analyst needs

some way of clarifying the picture. Besides off-centering and expansion, important aids to sorting out the objects, there is another feature: the analyst may devise his own scheme of brightness coding. By way of an example, he can set objects of little interest so that they and their histories will be dim. All other objects can be made to appear at a normal level, except for a designated object: it and its history can be especially bright. Any brightness coding scheme of the three levels can be established with one restriction. When an object is set to a given brightness level, any object (interceptor or RV) that is paired with it will automatically be set to the same brightness.

### Conclusion

The overall representation in four dimensions of space and time, with the off-centering and expansion features, would seem to provide a complete picture of the relation of interceptors to RV's, in position and by assignment, of the kind the analyst requires. As it turned out, the quality of the stereoscopic effect is very satisfactory. People with normal vision, or wearing their usual glasses, have no difficulty in perceiving the depth effects. There is, of course, the drawback that people with vision in only one eye cannot see stereoscopic depth. Indeed, one indication of the value of the third dimension is that a view with one eye is often difficult to interpret because of objects that fall on top of each other.

When the display is used on-line with the simulation program, evaluative experiments and observations will be carried out. Several questions need to be studied. They range from technical questions about the accuracy of depth perception to broad questions about the value of the display as an aid to solving intercept assignment problems.

Copies of the full report may be obtained from W. P. Harris, M.I.T. Lincoln Laboratory, Lexington, Mass. Further details on the optical viewer, the mathematics of stereoscopic viewing, and operational instructions for the display are published in the Appendixes of the report.

DECUSCOPE is published monthly for Digital Equipment Computer Users Society (DECUS).

Material for publication should be sent to: Angela J. Cossette, DECUS, Maynard, Massachusetts 01754. Telephone: AC 617 897-8821, TWX 710 347-0212

Publications Chairman: Joseph Lundy, Inforonics, Inc.

Circulation: 1,500 copies per month

DECUS acknowledges the assistance of Digital's Technical Publications Department in the preparation of this newsletter.

## SCOPE DISPLAY: CONTRAST AND TRACE PERSISTENCE

Donald A. Norman

Harvard University  
Cambridge, Massachusetts

We have discovered that the visual contrast of the image on the computer display can be improved greatly by placing a sheet of circularly polarized material over the face of the CRT. The polarized sheet darkens the background without appreciably changing the intensity of the generated image; moreover, it does not interfere with the operation of the light pen. The sheet is available from the Polaroid Corporation, Cambridge, Mass. 02139, as HNCP37 x .030". A 16" x 16" cellulose acetate sheet (0.030" thick) costs approximately \$15.

Phosphor used for the display (P7) has two different components. One, the blue component, has a trace that decays within 50  $\mu$ sec to approximately 10% of its excited intensity. This component has its peak light energy at 435 m $\mu$ . The other, the yellow component, has a trace that decays slowly, taking considerably longer to reach 10% of its excited level. This component has its peak energy at 555 m $\mu$ .

A yellow filter can be used to increase (slightly) the perceived persistence and, thus, reduce the amount of flicker. The light pen will not work properly through a yellow filter, so it is suggested that goggles or sun glasses be made. This causes the operator to see only the yellow component of the trace but lets the light pen work properly. A recommended filter is Wratten No. 16, available from Eastman Kodak in various forms (e.g., 3" x 3" gelatin film squares).

A blue filter can be used to reduce dramatically the persistence. Blue filters can be fashioned into goggles or put over the scope face. The light pen may or may not work through this filter, depending upon its density. A possible filter for this purpose is Wratten No. 47B, available from Eastman Kodak. Unfortunately, this filter is very dense even at its maximum transmittance, and severely attenuates the perceived image. One solution is simply to search art stores for blue plastic sheets.

---

### WANTED

Used Type 30 Display with or without character generator.  
Contact:

Mrs. M. Nyquist  
Inforonics Inc.  
146 Main Street  
Maynard, Massachusetts 01754

# DECUS NOTES

## DECUS SPRING 1966 SYMPOSIUM

The DECUS Spring 1966 Symposium will be held on May 25th and 26th at the Hotel Somerset, Boston, Massachusetts.

Papers regarding any of the PDP's, their peripheral equipment, and LINC are welcome. Those interested in presenting a paper at this symposium should submit a 75-100 word abstract by March 31st, along with an approximation of the time needed to: Mrs. Angela J. Cossette, DECUS, Maynard, Massachusetts 01754.

Further details will be published in the March DECUSCOPE. Registration forms and details regarding meals and hotels will be sent to all installation delegates within the next few weeks.

## BIOMEDICAL SEMINAR

In conjunction with the Spring Symposium, a Biomedical Seminar will be held on May 23rd and 24th at the Hotel Somerset in Boston, Massachusetts. Dr. Octo Barnett, Massachusetts General Hospital, will be the chairman for this session. Included on the program will be a demonstration of the Hospital Computer Project System. It is also planned to include discussion sessions on the various biomedical applications.

Those interested in presenting a paper or participating in the general discussion should contact Mrs. Angela J. Cossette, DECUS, Maynard, Massachusetts 01754. Those planning on presenting a paper should submit a 75-100 word abstract along with an approximation of the time needed by March 31st.

## EUROPEAN SEMINAR

A DECUS European Seminar was proposed recently for European members. Because of the distance involved, most European users cannot attend regular Spring and Fall DECUS Symposiums. It is hoped that this seminar will enable many of the European users to participate in the user group activities.

A two-day meeting in Western Germany in either March or April is planned. Questionnaires have been sent to several users in the area to access the degree of support that can be expected for such a meeting.

If you are interested in attending or participating in such a meeting, please contact Mr. Raymond Jones, Digital Equipment Corporation (UK) Ltd., 11 Castle Street, Reading, Berkshire, England.

## DECUS EXECUTIVE BOARD MEETING

A DECUS Executive Board Meeting was held on January 19 at Digital Equipment Corporation, Maynard. Mr. John Goodenough, DECUS President, presided. Topics discussed included the date and location for the Spring 1966 Symposium, report from the special committee studying DECUS/DEC relationship, and the proposed DECUS/JUG Workshop.

Mrs. Elinor Burns, representing 3C's users' group "CAP," attended and volunteered her efforts toward the formulation of the DECUS/JUG Workshop. A committee was formed consisting of Mrs. Burns, Richard McQuillin, Joseph Lundy and Angela Cossette, to plan the workshop. A committee meeting to begin preparations for the workshop was set for January 25.

All items placed on the agenda for the Board meeting were not covered and another meeting was set for February 2.

Minutes of these meetings will be sent to all delegates.

## JUG/DECUS WORKSHOP

On November 30, 1965 at the Las Vegas meeting of JUG, DECUS proposed a user group workshop which would be primarily a forum for executive board members of user groups to discuss their problems and future plans. JUG Secretary, Robert Rountree, polled the user groups and a majority expressed an interest and planned to attend.

A committee was formed and preliminary plans are under way. The meeting will take place on April 22nd and 23rd in the main conference room (lower level) of the John Hancock Building in Boston, Massachusetts. This will immediately precede the SJCC also in Boston on April 26-28.

The purpose of the workshop is to bring the user groups of JUG closer together. New user groups are in need of guidance, and new ideas and methods are of use to all. Topics for discussion will include:

1. The Executive Structure of User Groups
2. Operating User Groups Meetings
3. The Program Library
4. Publications
5. The Future of User Groups

An invitation and tentative program will be sent to all user groups that are presently members of JUG. However, user groups that are in the process of joining JUG and/or other groups who are interested in attending should contact a member of the committee (listed below) for details.

### JUG/DECUS Workshop Committee

Mr. Richard McQuillin  
Inforonics Incorporated  
146 Main Street  
Maynard, Massachusetts 01754  
Tel. 897-8815

Mr. Joseph Lundy  
Inforonics Incorporated  
146 Main Street  
Maynard, Massachusetts 01754  
Tel. 897-8815

Mrs. Elinor Burns  
Computer Control Corporation  
Framingham, Massachusetts  
Tel. 879-2600 Ext. 2566

Mrs. Angela J. Cossette  
DECUS  
Maynard, Massachusetts 01754  
Tel. 897-8821 Ext. 414

# DECUS PROGRAM LIBRARY

## PDP-1 PROGRAM LIBRARY ADDITIONS

### DECUS No. 82.3

Title: FORTRAN for the PDP-1 (Version 3)

This version, performed with the MUL/MUS switch set to MUL and the DIV/DIS switch to DIV, replaces Version 2 for machines with MUL DIV hardware. Errors found in Versions 1 and 2 have been corrected and several changes made. One important addition is a check for mixed mode arithmetic, or "if", statements. Mixed mode combines fixed-point and floating-point variables in one statement.

This version includes the FORTRAN "Print" Statement for use with a DEC Type 64 Line Printer. For systems without line printers, the following alteration can be made: change the clear print buffer instruction (730445) in location 4527 of the tape labeled "subroutine package" to a NOP instruction (760000).

### DECUS No. 86

Title: Precision Hypotenuse/Square Root Subroutine

Author: Nick Chase, Charles W. Adams Associates, Inc. (submitted with permission of the Air Force DX-1 Laboratories)

Precision Hypotenuse forms the 34-bit sum of the squares of two 17-bit 1's-complement deltas and takes the square root. Precision Square Root, indicated by coding within the comments, will calculate the 17-bit square root of a 34-bit number.

The symbolic version of the subroutine is in Drum Frap but will assemble with ordinary Frap. The subroutine occupies 3410 registers, uses automatic multiply and divide hardware, and requires a constant of 200000<sub>8</sub>.

### DECUS No. 87

Title: Buffered DECTape Read and Write Routines

Author: R.J. McQuillin, Inforonics, Maynard, Massachusetts

These routines simulate paper tape on DECTape; instead of PPA and RPA the user writes JSP WRITEDT READDT.

The routines take 1521<sub>8</sub> locations plus constants including two 400<sub>8</sub> word buffers for DECTape. The routines assume the computer is in extend and sequence break modes and return it to this state.

The characters are punched onto DECTape two per word, permitting 776<sub>8</sub> characters on one DECTape block. The first location in the DECTape block contains the number of characters within the block. If this number is less than 776, the file ends after the last character in the buffer. A special return is available when the READDT routine reaches the end of the file.

## DECUS No. 4-13

Title: FISP: Foxboro Interpretive Simulation Program

The PDP-8 simulator, designed for Foxboro's Service Center PDP-4, uses some Foxboro peripheral equipment. The only generally useful feature that requires Foxboro devices in the present simulator is tracing, which uses their Selectric type-writer module. It appears that with some modification the simulator could use the teleprinter for tracing.

Machine requirements for the simulator are:

1. PDP-4 with EAE and 8,192-word core memory to simulate with EAE Type 182, Teletype Model 33-ASR keyboard and printer, Reader Type 750, and Punch Type 75 with all utility functions except tracing.
2. PDP-4 with EAE, 8,192-word core memory, and Type 24 Drum to simulate a PDP-8 with the same options as above plus Memory Extension Control Type 183, one additional memory field, and Drum Type 250 with all utility functions except tracing.

Symbolic tapes and documentation are available from DECUS.

## PDP-5/8 PROGRAM LIBRARY ADDITIONS

### DECUS No. 8-28

Title: PAL III Modifications for PDP-8 and ASR-33

Author: Terrel L. Miedaner, Space Astronomy Laboratory, Madison, Wisconsin

This modification of the PAL III Assembler speeds up assembly on the ASR-33/35 and operates only with this I/O device. The symbolic tape is read only once, on pass 0, and stored in the machine. This pass initiates as does pass 1, except that both switches 0 and 1 must be down. Other passes of the assembly initiate normally, but do not end the symbolic tape.

If the program is too large for the buffer, the Teletype punches 50-200 codes before halting. If the program size is doubtful, it is advisable to leave the punch on during pass 0 and not continue to pass 1.

The user and symbol table starts at 2736 and the buffer begins at 3103, allowing room for 25 user symbols only. The highest location of the buffer is 7440. This leaves a buffer size of 4336<sub>8</sub> or 2270<sub>10</sub>, which is sufficient for a large program or a small program with many comments, owing one tape character per location. To increase symbol table size, constants at 1413 and 1414 may be adjusted. For instance, if 50 symbols are desired:

```
1413   BUF, 3246
1414   BUFCNT, -4172
```

A few other modifications have been made to aid in circumventing the slow speed of the Teletype. The length of the

leader-trailer tape has been shortened; there is no pass III leader punched; and the symbol table has no leader or trailer or either pass, making the symbol tape incompatible with DDT (an appropriate leader can be punched manually). To restore any of these characteristics, the appropriate statements in the modifications tape may be deleted.

Symbolic tape may be modified as above and a new binary tape produced. The binary tape must then read in after loading the assembler for modification. This process can be done each time the assembler is loaded, or the modified assembler can be punched as a complete separate tape.

DECUS No. 8-29

Title: BCD to Binary Conversion Subroutines  
 Author: Terrel L. Miedaner  
 Space Astronomy Laboratory, Madison, Wisconsin

These two subroutines improve upon the DEC supplies conversion routine. Comparison cannot be made to the DECUS-supplied fixed-time conversion, DECUS No. 5-6, because it is specified only for the PDP-5. One routine is designed for minimal storage, the other for minimal time. Both are fixed-time conversions; time specified is for a 1.6-μsec machine.

Minimal time routine: 73.6 μsec/32 locations  
 Minimal storage routine: 85 μsec/29 locations  
 DEC routine: 64-237 μsec/37 locations  
 Time for number D<sub>1</sub>, D<sub>2</sub>, and D<sub>3</sub> is 64 + (D<sub>1</sub> + D<sub>2</sub>) 9.6 μsec.

DECUS No. 5-30

Title: GENPLOT - General Plotting Subroutine  
 Author: M. Adamowicz, New York University

This self-contained subroutine is for the PDP-5 with a 4K memory and a CALCOMP incremental plotter. The subroutine can move (with the pen in the up position) to location (x, y), make an "X" at this location, draw a line from this present position to location (x, y), and initialize the program location counters. A binary, relocatable tape is available.

If the subroutine is to be relocatable, the titles are: MOve, PLOT, DRaw, and INit. The readin procedure is the same as for other relocatable subroutines.

If it is to be used as a normal binary tape, the subroutine will occupy registers 3600 to 4151 inclusive. The table below shows the function of each section and where it is entered.

<u>Title of Section</u>	<u>Octal Entry Address</u>	<u>Operation Performed</u>
MOve	3800	The plotter pen is picked up and moved from present position to location (x, y). The x-component is given in the AC and the y-component is given after the JMS instructions.

PLOT	3602	The pen is moved as in the MOve section to location (x, y) and an "X" is made.
DRaw	3604	An approximating straight line is drawn from the present position to location (x, y). The x-component is given in the AC and the y-component is given after the JMS instruction.
INit	3606	The x and y plotter location counters are set to 0.

## NEWS ITEMS

### PDP-8 SYSTEM FOR DISPLAY-CENTERED SERVICE BUREAU

Computer Graphics of Gardena, California will use a PDP-8 computer system to develop display-centered systems for processing commercial, educational, engineering, and scientific data.

Computer Graphics will use Digital's PDP-8, magnetic tape transport, cathode ray tube display, and light pen with its own flying spot scanner in such work as making training films, reading physics and oil well data from film, and making television commercials. Other application areas include astronomy, biomedicine, law enforcement, meteorology, printing, and seismology.

In some studies the cathode ray tube will serve in an output mode, with analog data being converted and formatted by the computer for presentation and photographing on the screen. In others, the display will analyze an existing image, such as sales slips, fingerprints, or views of blood cells.

The new system can also read strip and circular charts used to record the results of cardiac and encephalographic examinations or to record environmental conditions. Engineering drawings or sketches can also serve as inputs.

Programs and routines developed by Computer Graphics enable the computer-controlled scanner to follow a line separating shades of gray as in analyzing cloud cover photographs, follow tree-like patterns as in scanning bubble chamber films, and vary sensitivity to insure uniform finished line weight as in transforming rough engineering sketches into formal drawings.

High-speed printing and the generation of scientific and commercial graphs and charts are some other capabilities of the system.

Technical staff director of Computer Graphics is Dr. Roger L. Fulton, who developed programs for an early scanning system at Lawrence Radiation Laboratory and also prepared the programming for a computer-generated motion picture on quantum mechanics.

## PHYSICISTS AT HEIDELBERG TO SCAN FILMS WITH PDP-7

The Institute for High Energy Physics of the University of Heidelberg has ordered a PDP-7 computer for use in one of its film analysis systems. The institute is one of several in Europe which design experiments to be carried out at the 30-billion-electron-bolt proton synchrotron at CERN in Geneva.

Exposed film from such an experiment, containing some 10 million pictures of particle tracks photographed in a large bubble chamber, is brought to Heidelberg for evaluation. The film is first scanned and each track measured by operators at 10 electro-optical tables connected on-line to the PDP-7. Using the numbers fed into it by the table instrumentation, the computer constructs in its memory three-dimensional trajectories of the tracks being measured.

Two tracks are measured per bubble chamber event. From range, from curvature, and from the direction angles of the tracks the center-of-mass momentum and its error are computed for one of the tracks.

On the basis of this center-of-mass momentum, the computer decides whether the event should be singled out by the operator for further study or whether it should be passed over. The computer output from the scanning operation is a perforated tape containing a brief record of each event studied as well as the numbers of those photographs which contain tracks to be analyzed further.

Use of the PDP-7 is expected to reduce from 10 million to 100 thousand the number of photos from a typical experiment which must then be examined more closely on the institute's existing precision film measuring system.

## COMPUTER OPTIONS

Digital Equipment Corporation heralds the advent of a two-in-one laboratory computing system, combining the basic system concepts and operating simplicity of the LINC with the speed and memory advantages and the variety of peripheral devices available with the PDP-8.

The new system is the LINC-EIGHT, designed to control experiments and collect and analyze data in biomedical and environment science research. LINC-EIGHT combines the best equipment features of the two earlier computers and lets the user choose between the two programming systems available.

The LINC-EIGHT includes the multiplexed analog-to-digital inputs and relay register output provisions of the LINC, plus its dual digital LINCtape transports and integral alphanumeric oscilloscope display. The LINC-EIGHT incorporates the PDP-8's 1.5- $\mu$ sec memory ranging in capacity from the basic 4096 words to a maximum of 32,768. LINC-EIGHT also

utilizes the PDP-8's bus concept for additional input/output convenience.

Like the earlier LINC, the new system communicates with its users by displaying their instructions and results in intelligible alphanumeric form, and it executes the complete order code of 48 instructions.

The LINC-EIGHT uses the field-proven LINC software, designed to let the researcher write his own operating programs after a minimum of instruction. It also uses the PDP-8 programming system, which includes a sophisticated FORTRAN as well as aids written for the beginning user.

To familiarize purchasers with the new system, Digital offers four courses in programming and maintaining the LINC-EIGHT and the PDP-8.

Typical biomedical applications for the new system are in arterial shock wave measurements, in-phase triggering of stimuli from EEG alpha waves, processing of single-unit data from the nervous system, EKG processing, and operative conditioning applications.

In addition to its applications in life science laboratories, Digital says the new LINC-EIGHT is also designed for research in chemistry, geology, meteorology, oceanography, psychology, radiation, seismology, and sound.

The LINC-EIGHT software system includes the complete PDP-8 software, plus the LINC's LAP4 Assembly System and Language, the GUIDE System, and convenience programs. Like the hardware, LINC software was developed for on-line, real-time research under grants from the National Institutes of Health and the National Aeronautics and Space Administration. Development began at Massachusetts Institute of Technology and continued at Washington University in St. Louis.

LAP4 makes it possible for the investigator to prepare programs with the assistance of the LINC-EIGHT oscilloscope display. He teletypes in his program at the console, and the display shows him each completed instruction before it is stored. LAP4 then converts his program into a binary program which actually controls the system during his experiment or data analysis.

GUIDE is a system of routines to control a file of machine-language programs stored on the LINCtape. It lets the user easily retrieve and execute any of the programs, delete old ones, and add others. A significant characteristic of GUIDE, as well as of the other LINC programming aids, is that it displays alphanumeric information to provide a rapid, direct interaction between the user and the machine to speed and simplify error detection and correction.

The programming system for the PDP-8 consists of the Symbolic On-Line Debugging Program, MACRO-8 Symbolic Assembler, FORTRAN System Compiler, Symbolic Tape Editor, Floating Point Package, mathematical function subroutines, and various utility and maintenance programs.

Because so many of the earlier computers are in use (43 LINC's, 125 PDP-8's) large libraries of operating programs have been built up and will be available to LINC-EIGHT users through DECUS.

# NEW DECUS MEMBERS

## PDP-1 DELEGATES

R. deSaussure  
(replaces R. Conn)  
Lawrence Radiation Laboratory  
Livermore, California

Mrs. J. P. Fishman  
(replaces Neil Stutz)  
Princeton-Penn Accelerator  
Princeton, New Jersey

## PDP-1/6 DELEGATE

Orin C. Hansen, Jr.  
Yale Brookhaven  
High Energy Physics Group  
J. Willard Gibbs Laboratory  
New Haven, Connecticut

## PDP-5 DELEGATES

Friedemann Aklolk  
Deutsches Elektronen Synchrotron  
DESY  
2 Hamburg 52, Germany

Donald P. Hamm  
Lockheed-California Company  
Burbank, California

Donald F. Wann  
Washington University  
St. Louis, Missouri

## PDP-6 DELEGATE

Frank Harris  
Oxford University  
Nuclear Physics Laboratory  
Oxford, England

## PDP-7 DELEGATE

K. E. Wittmer  
Bell Telephone Laboratories, Inc.  
North Andover, Massachusetts

## PDP- 8 DELEGATES

Paul E. Condon  
University of Maryland  
College Park, Maryland

Sharon Garner  
Harvard Medical School  
Boston, Massachusetts

B. C. Kent  
Goodyear Research  
Akron, Ohio

R. I. MacDonald  
UKAEA Harwell  
Didcot, Berkshire, England

J. McL. Emmerson  
Oxford University  
Oxford, England

Sigmund Navdal  
Chr. Michelsens Institute  
Bergen, Norway

Robert D. Sanders  
Sylvania Electronic Systems  
Waltham, Massachusetts

## PDP-8/LINC DELEGATE

Donald Langbein  
Eaton-Peabody Laboratory  
Mass. Eye & Ear Infirmary  
Boston, Massachusetts

## LINC DELEGATES

John B. Lewis  
M.I.T. - Lincoln Laboratory  
Lexington, Massachusetts

Harold W. Shipton  
State University of Iowa  
College of Medicine  
Iowa City, Iowa

## INDIVIDUAL MEMBERS

Mark Connelly  
M.I.T. Electronic Systems Lab.  
Cambridge, Massachusetts

J. Robert Hippensteele  
University of California  
Donner Laboratory  
Berkeley, California

Mary Anne Kelley  
Brookhaven National Laboratory  
Upton, L.I., New York

R. W. Roberts  
Barringer Nuclear Limited  
Rexdale, Ontario, Canada

Robert H. Simmons  
Inforonics Incorporated  
Maynard, Massachusetts



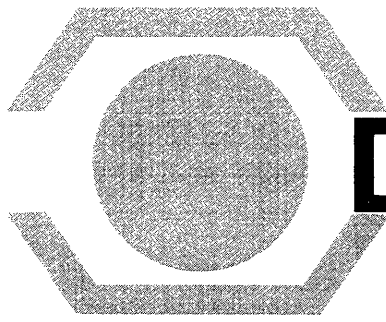

# DECUSCOPE

DIGITAL EQUIPMENT COMPUTER USERS SOCIETY

February 1966  
Vol. 5 No. 2

## THE LEARNING RESEARCH AND DEVELOPMENT CENTER'S COMPUTER ASSISTED LABORATORY

Ronald G. Ragsdale  
University of Pittsburgh  
Pittsburgh, Pennsylvania

In April of 1964, the Cooperative Research Branch of the United States Office of Education established a research and development center at the University of Pittsburgh as part of the Office of Education's program to provide major concentrations of effort in various areas in education. The Center at the University of Pittsburgh is called the Learning Research and Development Center (LRDC) which directs its activities to design and development of instructional practices on the basis of experimental research on learning.

One of the activities along these lines has been the construction of a computer-assisted laboratory as a first step of a project on computer-assisted instruction.

The Computer-Assisted Instruction Project has two principal objectives which guide the scope of effort undertaken within this group. The first objective is to provide those facilities and services needed to support the research and development effort of experimental psychologists and others working in the field of instructional technology. The facilities include apparatus and controls used in conducting learning experiments which make use of computer-related equipment. The group also provides engineering and programming assistance in the design and conduct of experiments. This service is primarily for the Center staff but may be used by other faculty members.

The second objective of this group is to conduct experimental work in the development of computer-based instructional systems. Examples of such work include the development of supervisory programs for controlling many independently operating stations; the development of language that educators can use for implementing subject matter programs on the computer; and the development of student stations to provide a greater degree of interaction between the student and the subject matter.

### Hardware

The main piece of hardware in this project is a Digital Equipment Corporation PDP-7 computer, installed in mid-June 1965. In addition to the standard PDP-7 configuration, this computer has 8,192 words of core memory, 16

levels of automatic priority interrupts, the extended arithmetic element, 100 card-per-minute reader, variable time clock with speeds up to 1000 cycles per second, 2 output relay buffers and terminals for connecting student devices to the computer. The core memory will soon be increased to 16,384 words, with the additional 8,192 already on order. It is anticipated that magnetic drum storage will soon be added to the system as well.

In addition to the computer room, shop area, and an auxiliary equipment room, there are eight separate laboratory areas which average about 180 square feet. The labs range in size from 140 square feet to 285 square feet, with two of the larger labs having observation areas separated from the lab room by one-way glass.

Each laboratory area is connected to the computer room by electrical ducts. This allows a great deal of flexibility in assigning display and response equipment to the student station. Basic equipment for a student station consists of a keyboard, a cathode ray tube with light pen and an audio speaker or head set.

Most basic is the keyboard, which is a modified Type-33 Teletype keyboard. There is no printer associated with the keyboard, this function usually being served by an oscilloscope screen (a Techtronix RM 564 connected with a Type 34 Interface). This scope can be operated in a "stored" mode in which information on the screen is preserved and does not have to be refreshed. When the scope is in the "dynamic" mode (selected under computer control), it may be used with a light pen.

Another basic device is the audio speaker or head set. Audio information is stored on loops of 6-inch wide magnetic tape. Each loop has 128 tracks, with 16 play and record heads each servicing 8 tracks. The size of the loop is variable, but at present, they hold 1,024 seconds of information with each 1-second block individually addressable. Although it is not a standard item, there may also be a microphone at the student station so that he can record on certain areas of the tape reserved for this purpose through software.

In addition to the basic student station devices, a number of special and experimental devices exist. One special device already in operation is the "touch-sensitive display." A random access slide projector is focused on a back-lighted screen which displays the information for the student. Embedded within the screen are many fine wires which allow the detection of an object, such as a finger or pointer, striking the screen. Detection of such a response also specifies the location of the response upon the screen. Since the projector and the screen are both under computer control, visual stimuli may be sequenced according to the position of the preceding response(s).

Other devices under development include graphic tablets like the "RAND tablet" and "manipulation boards." The graphic tablet is a device through which a student may input graphical information directly to the computer using an electronic pencil. The tablet, used in conjunction with appropriate diagnostic routines, permits the teaching of printing and drafting, to name only two examples, in a manner which allows easy detection of student errors.

RAND Corporation uses their graphic input tablet for debugging programs. A scope displays the contents of several standard locations plus some memory location. The programmer can search memory upward or downward by pointing the electronic pencil at the appropriate spot. If he wishes to change the contents of a displayed memory location, he can do so by merely writing over the display with the electronic pencil.

The manipulation board detects the placement of objects on its surface and relays the corresponding bit pattern to the computer; as in the RAND tablet, a bit pattern must be recognized. In this case, however, the set of objects, such as blocks representing different number quantities, can be restricted to those easily identifiable. With such a restriction, the set of objects can be identified both as to item and location upon the board. This device should be particularly effective in working with young children, or the mentally retarded, since it puts very little demand on the student insofar as the structure of the response is concerned.

Availability of a device for magnetic storage of video information is planned for the near future. This device will permit the storage of approximately 500 pictures combining video camera or computer-plotted output. The selection of pictures is to be under computer control and additional points may be plotted on the selected picture at any time. This system will also permit use of a light pen.

#### Software

The present software system, still in the final debugging state, consists of a set of control programs for each of the various devices as well as an executive system to control the sequencing of jobs, timing, memory allocation and the like.

All of the teaching or experimental programs being contemplated are those involving a student response or some time delay. When this happens, the program returns control to the scheduler part of the executive system for another job. In general, this system should have the capability of servicing six devices of each type, although at present only one of each is in use.

Most of the 16 priority levels are used presently by the system. The 60-cycle and 1000-cycle clocks each use 2 levels. Keyboards, light pens, touch-sensitive displays, microphones, and audio tapes require priority levels based upon the speed of the response they demand. In addition, the executive routine responds to a priority level which can be activated through software.

This interrupt, which has the lowest priority level, is set whenever an interrupt signals the end of job suspension. When all other interrupts have been processed, the scheduler regains control and can reinitiate this job.

Programming of learning experiments, teaching routines, etc., is by machine language at present. A large part of the coding would be subroutine calling sequences to reference control programs. This type of programming can be more difficult and time consuming, but it offers maximum flexibility.

One major goal of the Computer-Assisted Instruction Project is the implementation of a language which educators can use easily for programming subject matter on the computer. Several steps are involved before reaching the final goal in this area, a compiler which accepts lessons written in some behaviorally oriented language and translates them into the proper codes. The first, and probably the most important, is the definition of terms to denote particular instructional subsequences, etc. From this foundation, one can proceed until a final compiler is defined and operating.

#### Individualized Instruction

A project planned to merge with the Computer-Assisted Laboratory is now being carried out in a suburban Pittsburg elementary school. In this school, students are allowed to progress at their own rate through curricula in mathematics, reading and science, as they might in a computer-assisted classroom. Each unit of instruction consists of skills which must be mastered with appropriate instructional materials and progress and quality control tests provided for each skill. Materials provide a considerable library of instructional sequences and relevant information for each skill and the teacher must "prescribe" those materials which she feels are most appropriate. It is clear that a curriculum of this type lends itself well to computer instruction, the major difficulty being simulation of the teacher's decision process.

#### Learning Experiments

The development of a library of programs relevant to learning experiments is less structured. There are certain basic paradigms which provide a basis for such a library, but the need is for more flexibility, in addition to implementing old routines.

Two major objectives in the learning experiment area are: experimental design and real-time data analysis. In the design and control of learning experiments, programs would assign subjects to groups on the basis of certain control variables; they would monitor information such as anxiety level, for example, and modify it if necessary; and they would equate the subject's performance on a certain task prior to

application of the experimental treatment by the assignment of appropriate training or by statistical adjustment. These programs would perform tasks usually requiring lengthy subject selection prior to the experiment or the conduct of preliminary base-line pilot studies.

Closely related to these programs are programs for real-time data analysis which provide data for the control and design section. This would permit, for example, use of complex criterion measures in equating the performance of subjects. This type of data analysis would be especially helpful in a pilot study, since one could start out with a large number of variables and, as the analysis indicated, discard the obviously relevant or obviously irrelevant to concentrate on the more marginal variables. Eventually the system might assist in selection of variables of interest and assignment of experimental treatments. The system would also analyze data, and terminate the experiment when sufficient precision was attained.

This paper was presented at the DECUS Fall 1965 Symposium and is also published in the proceedings of this meeting.

## PROGRAMMING NOTES

### CHECKING PDP-8 BINARY TAPES

M. Q. Barton  
Brookhaven National Laboratory  
Upton, N.Y.

The ASR-33 Teletype unit, associated with the PDP-8, is a weak link in the system in both speed and reliability. Thus, for example, the PAL III Assembler is quite capable of preparing a tape with a checksum error. This would be slightly less exasperating if discovered at the end of the assembly because one could repeat pass two and prepare a new tape, rather than reload the assembler and repeat both passes. This is easily done by the following procedure:

1. Using the console switches, replace the 3616 in location 7741 by a 7200 and clear accumulator. The 3616 is the instruction in the binary loader which loads tape contents into memory.
2. Set switches to 7777, press LOAD ADDRESS, place binary tape in reader, and press START. The binary loader reads the tape and does checksum calculation, but because of step 1 does not load tape.
3. When the computer halts at the end of the tape, a 0 in the accumulator indicates a tape with proper checksum. The assembler and symbol table are still intact so the operator can immediately rerun pass two if the tape is indeed faulty. He just puts 200 in the switches, presses LOAD ADDRESS, sets the switches for pass two, puts the symbolic tape in the reader, and presses START.
4. Reload 3616 in location 7741 before trying to use the binary loader for its normal function.

## DECUS PROGRAM LIBRARY

### PDP-5/8 PROGRAM LIBRARY ADDITIONS

#### DECUS No. 5-31

Title: FORPLOT - FORTRAN Plotting Program for PDP-5  
Author: Jerome Feder, New York University, Department of Electrical Engineering

FORPLOT is a general-purpose plotting program for the PDP-5 computer in conjunction with the CALCOMP 560 Plotter. It is self-contained and occupies memory locations 0000<sub>8</sub> to 4177<sub>8</sub>. FORPLOT accepts decimal data inputted on paper tape in either fixed or floating point formats. Formats can be mixed at will. PDP-5 FORTRAN output tapes are acceptable directly and any comments on these are filtered out.

FORPLOT scales input data. The operator informs the computer, in advance, of the data values to be assigned to the top, bottom, right, and left plot boundaries. There are no restrictions on these data values. It is not necessary that any of them be zero, nor is it necessary that the top and right boundaries correspond to more positive data values than the bottom and left boundaries, respectively.

All plotted graphs are 10 inches in the ordinate direction. The operator controls the length of the abscissa which may reach a maximum of 39.99 inches.

A number of plot format options are available to the user. The program is capable of drawing an abscissa and ordinate axis, each ticked at intervals of 1 inch, at the right and bottom boundaries of the plot, respectively. If the user chooses to omit these axes, a circled point is placed at the starting point to indicate the bottom-right plot boundary. Points are left unconnected unless connected through user control. Finally, at the option of the user, FORPLOT can locate either a small "x" or a small octagon (approximately 1/16 inch across), or a superposition of both at each plotted point to make the point more plainly visible.

A column selection feature is provided enabling the operator to select data columns from tapes containing several of them. In this bulletin "column" refers to a column in the arrangement of the data when it is printed on the ASR-33. If desired, the operator can supply only the ordinates and the program will space the plotted points uniformly in the abscissa direction according to a preset constant.

#### DECUS No. 5/8-32

Title: Program to Relocate and Pack Programs in Binary Format  
Author: J.W. Bowman, Chalk River Nuclear Laboratories, Canada

This relocation program allows automatic transfer of a program in binary format into any portion of memory, no matter what starting address it has been allocated. Each program is

given a fixed starting address, allowing it to be loaded in the normal manner without using the relocation program. This includes moving a program to an entirely different starting address on a different page of memory. The program is now in use at CRNL and is proving a most effective tool in assembling a combination of existing programs and in amending and fault-finding new programs.

This package includes three programs to aid in relocating and retrieving subroutines:

1. A Clear Memory routine which clears registers 200<sub>8</sub> through 3777<sub>8</sub>. Length is 12 locations.
2. A programmed display routine which displays the entire memory. Empty registers appear on the base line while occupied addresses appear as 4096 counts on the display. The length is 15 locations.
3. Because it is often necessary to retrieve relocated programs on paper tape, a punch routine is included which punches those areas of the first half of memory which contain the program. The punch program senses and deletes gaps in memory.

This program saves much time since starting and ending addresses need not be remembered as with ODT and other types of binary punch programs.

The tape is punched in binary format complete with checksum, and is preceded by and followed with a length of leader. The length is 90 locations.

The relocation program and associated programs are themselves relocatable.

DECUS No. 5/8-33

Title: Tape to Memory Comparator  
 Author: Milton Collins, Teradyne, Boston, Mass.

Tape to Memory Comparator is a debugging program which allows comparison of the computer memory with a binary tape. It is particularly useful for detecting reader problems, or during stages of debugging a new program.

A typeout occurs whenever the memory disagrees with the contents of the binary program tape. The typeout consists of the memory location, contents of memory, and contents of the tape on one line. The checksum is typed out as an error at one location greater than the last address on the tape.

Presently, the program uses a high-speed reader; however it may be modified for the TTY reader. The program occupies 165 octal locations on a single page. It does not use page 0 or autoindex registers.

DECUS No. 7-10

Title: DECPUN  
 Author: Luther C. Abel, Rensselaer Polytechnic Institute, Troy, New York

DECPUN is a decimal integer punch routine. This permits raw data, as acquired by a PDP-7 in an on-line installation, to be punched out. Modification of the standard decimal integer print package (DEC 7-15-0) does not permit the operator to punch out numbers greater than 2<sup>17</sup>. Since many times data is considered to be all positive numbers (e.g., counts), DECPUN treats all numbers as positive, allowing for the full 2<sup>18</sup> machine capacity. This routine calls PDICIT to punch one digit. The user must supply the correct routine for the paper tape code being used. (See note under POSPNT.)

DECUS No. 7-11

Title: POSPNT  
 Author: Luther C. Abel, Rensselaer Polytechnic Institute, Troy, New York

This is a positive decimal integer print package. It is similar to DECPUN, except all numbers are treated as positive. It is available in two versions. POSPNT I in which initial 0's are printed, and POSPNT II which suppresses initial 0's. Both versions call TDIGIT from the Teletype Output Package (DEC 7-10-0); POSPNT II also calls TSP.

NOTE: DECPUN and both versions of POSPNT are written so that less than the full six decimal digits may be punched or printed if so desired. (Of course, the binary number must be within this reduced range). In the sequence of instructions before calling DECPUN or POSPNT, the following instructions are included:

```

.
.
.
LAC (LAM-x)
DAC DCPUN1-4/(or PSPNT1-4)
LAC (TAD DCPUN5+y)/(or PSPNT5+y)
DAC (DCPUN2+2)/(or PSPNT2+2)
.
.
.
LAC ---
DECPUN
    
```

In the above sequence, X is one less than the number of digits desired, and Y is 6 (number of digits desired). Note that X+Y = 5 always.

The TAD DCPUN5 instruction located at DCPUN2+2 is destroyed (by incrementing) in running the routine. It is restored to its starting 6-digit value at the end of the routine, as is the LAM-5 instruction at DCPUN1-4; thus the routine

is always ready to produce a 6-digit number merely by the command DECPUN. Incidentally, this trick cannot be done with the standard DECPNT (DEC 7-15-0) routine, since it restores the equivalent instruction (ADD DCPTAB) when entering rather than while exiting from the routine.

## DECUS No. 7-12

Title: Punch Output Package

Author: Luther C. Abel, Rensselaer Polytechnic Institute, Troy, New York

This is an output package for punching IBM compatible 7-line paper tape code, as used with the IBM 1620, or the IBM Model 26 tape-card converter and punch. Routines included are: PDIGIT to punch one BCD digit on tape (called with digit in AC, adds correct parity, etc.), PUNSP to punch a space (842) character, PUNEOL to punch an end-of-line (column 8) punch, PUNLDR to punch a leader on the tape (128 lines of all 7 columns). A routine OPUN must be supplied to punch each character as generated by the package.

## NEWS ITEMS

### BACTERIA-SCANNING SYSTEM CONTROLLED BY PDP-6

A computer-based scanning system to study bacteria, viruses, and other microorganisms which infect man is being built by the University of California at Berkeley under a grant from the Public Health Service.

The primary purpose of the research program, which will use the new system, is to make an intensive study of the hereditary characteristics of microbes. Investigators will try to learn what nutrients the microorganisms need, to what drugs they are sensitive, and what happens to them in various temperature, lighting, and environmental changes.

The scanner will also serve as an experimental diagnostic system to identify infectious diseases sooner than is now possible. More rapid diagnosis, permitting faster selection and administering of the most effective drug, could result in more rapid recovery in addition to shedding light on the genetics and physiology of the microorganisms.

The system is being built as part of a 5-year, \$1.24-million program to be administered by the National Institute of General Medical Sciences. Directing the program is Dr. Donald A. Glaser, professor of physics and molecular biology at the University and a Nobel prize winner in physics.

The new system, similar in concept to others being used in several leading physics laboratories to study the structure of the atom, will identify microbes by comparing them with stored images of all known types. Dr. Glaser believes identification may be possible within 12 to 18 hours after examining a patient, rather than after the 48-hour incubation period commonly needed now.

The system will be controlled by a PDP-6 computer. Stored in its memory will be characteristic patterns of known microbes. Examining the unknown microbes in a specimen

taken from the patient will be an optical device known as a flying spot scanner.

The scanner uses a cathode ray tube as a light source and a light-sensitive device as a detector. The specimen is positioned between them, and the light beam of the cathode ray tube sweeps repeatedly across the specimen under control of the computer. The varying amounts of light reaching the detector as the light beam passes from transparent to opaque areas of the specimen enable the computer to recreate in its memory the mathematical representation it needs to compare the unknown and known patterns.

The system's speed in scanning and identifying the new pattern, its ability to store many variations of the numerous types of microorganism patterns, and its ability to detect characteristic patterns before a human observer are all expected to contribute to faster diagnosing.

After the infectious agent is identified, the system can command an automatic petri dish machine to treat it with penicillin or other drugs. Again, following treatment, the scanner can examine the specimen to determine whether the chosen drug will be effective in treating the patient.

Computer-controlled scanning systems in physics laboratories examine photographs showing paths made by colliding subatomic particles. Each photograph of the many thousands taken during a typical experiment is examined to record in the system the information needed to identify the various particles shown. In this work, the system examines many simple patterns to select the few in which the investigators are primarily interested.

In the University of California's system--believed to be the first attempt to extend the technique to the life sciences--the emphasis will be on examining fewer, more complex patterns. In another departure from previous scanning methods, the Berkeley system will attempt to recognize degrees of gray, rather than the more common black and white differentiation.

### ARGONNE LABORATORY USES PDP-7 FOR FILM-SCANNING DEVELOPMENT

Argonne National Laboratory in Chicago is using a PDP-7 computer and peripheral equipment to continue a film-scanning development program in the laboratory's low energy physics studies.

The new system based on the PDP-7 is known as POLLY. It reads data recorded on film up to 70 millimeters wide and displays it on cathode ray tube screens. An operator observes images being shown on one display while precision measurements are made automatically on others. POLLY differs from its predecessor by accepting larger film and providing a more flexible method for handling data.

The computer is also being used in the study of particle motion planes, in which proton deflections caused by various force fields are measured precisely.

The equipment is being developed by the laboratory's Applied Mathematics Division, which provides computer programming

assistance and develops special-purpose computer equipment for other laboratory divisions.

Argonne is operated by the University of Chicago for the Atomic Energy Commission.

### 10 PDP-8 COMPUTERS FOR NEW AUTOMATIC DRAFTING SYSTEM

Airborne Instruments Laboratory Division of Cutler-Hammer Incorporated plans to use ten PDP-8 computers in the control portion of a new automatic drafting system.

The new system combines an ORTHOMAT drafting machine with the DECAMATIC Expandable Stored Program (ESP) Control. The latest system in the growing field of numerically controlled engineering drawing, it is being manufactured in a joint program by Airborne Instruments of Deer Park, N.Y. and Universal Drafting Machine Corporation of Cleveland.

In addition to its primary function, engineering drawing, it can also be used for making precise layouts or measurements of existing prints and plans, and it can produce punched tapes containing feed rates, cutter paths, and similar data to control automatic machine tools.

Automatic drafting machines, originally used in aerospace projects, have since spread to the automobile industry, architecture, civil and marine engineering, and other fields in which design, layout, and drafting activities represent a significant investment of engineering manhours. One of their chief benefits is cutting the time and effort needed to prepare detailed graphical presentations, letting the engineer spend more time designing.

### PHYSICS INSTITUTE IN MUNICH TO USE PDP-8'S IN HIGH ENERGY PHYSICS RESEARCH

The Max Planck Institute for Physics and Astrophysics in Munich will use two PDP-8 computers to control systems analyzing data in high energy physics research.

The data on photographic films shows tracks of high energy particles interacting in the liquid of a bubble chamber. The two systems will permit rapid and precise coordinate measurements of tracks in a large sample of events.

In one system, the PDP-8 will initially connect on-line to two high precision measuring projectors and two scanning tables. The computer will notify the operators which tracks to measure and when to repeat measurements if errors occur. An appreciable gain in speed over off-line measuring techniques is expected.

This PDP-8 will include an extended arithmetic element, memory parity option, a 4096-word core memory, and a semi-automatic control which permits the transfer of data on magnetic tape to a second computer for more detailed analysis.

The second system includes a standard PDP-8 to be used as a medium-speed, intermediate buffer for an automatic film reading application. The PDP-8 will connect on-line to a large computer and will further check the film-reading system without requiring the intervention of the large computer.

## COMPUTER OPTIONS



Model 563, Model 564

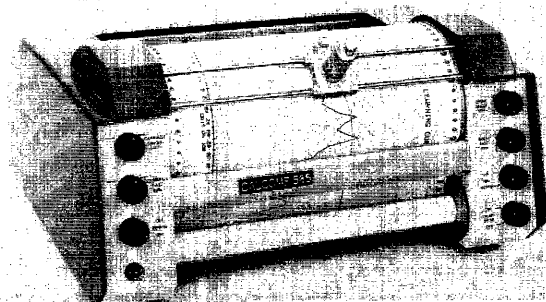

Model 565, Model 566

### INCREMENTAL PLOTTER AND CONTROL TYPE 350B

The Incremental Plotter and Control Type 350B provides the user of DEC PDP-7 or PDP-8 computers with on line incremental plotting capability.

This equipment efficiently plots computer generated data with unvarying accuracy on high-quality ink-on paper. Complete freedom of format permits pictorial presentation involving any desired combination of lines and axes, an unlimited variety of symbols, and choices of sizes and angles.

The following eight computer instructions control the Type 350B:

Move drum up or down	} may be combined for diagonal motion
Move pen right or left	
Pen up or down	
Test for plotter ready flag	
Clear plotter ready flag	

The Type 350B Control connects to the interrupt and skip system permitting fully buffered operation of the plotter on an interrupt basis.

Bidirectional step motors are employed for both the X and Y axes. Plotting is produced by the movement of a pen relative to the surface of the recording paper or vice versa, with each input pulse causing a step of either .01 inch or .005 inch in either or both the X and Y plotting axes. Electrical signals raise or lower the pen from the surface of the paper. Curves and symbols of any shape may be produced by the proper combination of incremental motions generated by the appropriate computer commands.

Each incremental command produces motion of the pen in one of eight directions. The model selected determines the magnitude of the step size, typically .01 inch or .005 inch.

These digital plotters operate in discrete steps provided by specially designed step motors which use precision gearing to provide completely drift-free operation. Accuracy never depends upon voltage stability as is required in systems which convert digital signals into analog voltages to position an analog servomechanism.

## GENERAL PURPOSE D-A CONVERTER TYPE AA01A

The Type AA01A D-A converter is used with PDP-7 or PDP-8 computers to convert 12-bit binary numbers to analog voltages. Each AA01A contains three separate converters and three digital buffer registers. Register updating is accomplished through one 12-bit input channel. When the AA01A is used with a PDP computer, one IOT instruction simultaneously selects the converter and transfers the digital number. The AA01A, mounted in a standard 5-1/4 inch, 64-position panel, uses DEC FLIP CHIP modules.

The output analog voltages are interfaced using a standard DEC W028 Signal Connector. Three operational amplifiers (DEC Type A201) may be plugged in to provide low output impedance, larger driving capability, or output scaling from each DAC. Regulated power for the optional amplifiers must be provided by a separate supply (DEC Type H702) when the amplifier option is required.

Single level buffering in the AA01A results in the most economical conversion of 12-bit binary numbers. Double-buffered converters are also available.

## NEW DECUS MEMBERS

### INDIVIDUAL MEMBERS

- |   |  |   |
|---|--|---|
| Robert W. Allison, Jr.<br>Lawrence Radiation Laboratory<br>Berkeley, California | Stephen F. Jackson<br>United Aircraft Corporation<br>East Hartford, Connecticut            | Harold W. Richmond<br>Computing Technology Incorporated<br>Tuxedo, New York     |
| Donald P. Anderson<br>United Aircraft Corporation<br>East Hartford, Connecticut | Martin D. Levine<br>McGill University<br>Montreal, Quebec, Canada                          | Milton N. Saltzman<br>United Aircraft Corporation<br>East Hartford, Connecticut |
| Douglas Chine<br>University of Rochester<br>Rochester, New York                 | John S. MacDonald<br>University of British Columbia<br>Vancouver, British Columbia, Canada | David H. Sorenson<br>United Aircraft Corporation<br>East Hartford, Connecticut  |
| Henry Gertzman<br>University of Rochester<br>Rochester, New York                | Paul T. McKiernan<br>United Aircraft Corporation<br>East Hartford, Connecticut             | Constantine Stefanu<br>Veteran's Hospital<br>Birmingham, Alabama                |
| Ronald E. Gocht<br>United Aircraft Corporation<br>East Hartford, Connecticut    | P. S. Meigs<br>Bell Telephone Laboratories Incorporated<br>North Andover, Massachusetts    | John M. Sweeney<br>Lawrence Radiation Laboratory<br>Berkeley, California        |
| David Goldstein<br>Computing Technology Incorporated<br>Tuxedo, New York        | G. L. Murray<br>University of Oxford<br>Oxford, England                                    | Morton M. Traum<br>American-Standard<br>New Brunswick, New Jersey               |
| Yale Grayson<br>Computing Technology Incorporated<br>Tuxedo, New York           | Ian George Nicholls<br>University of Western Australia<br>Perth, Western Australia         | Donald S. Williams<br>University of Pittsburgh<br>Pittsburgh, Pennsylvania      |
| Eivind Hognestud<br>Chr. Michelsens Institute<br>Bergen, Norway                 |  | Christiane Andree<br>Oxford University<br>Oxford, England                       |

DECUSCOPE is published monthly for Digital Equipment Computer Users Society (DECUS).

Material for publication should be sent to: Angela J. Cossette, DECUS, Maynard, Massachusetts 01754. Telephone: AC 617 897-8821, TWX 710 347-0212

Publications Chairman: Joseph Lundy, Inforonics, Inc.

Circulation: 1,500 copies per month

DECUS acknowledges the assistance of Digital's Technical Publications Department in the preparation of this newsletter.

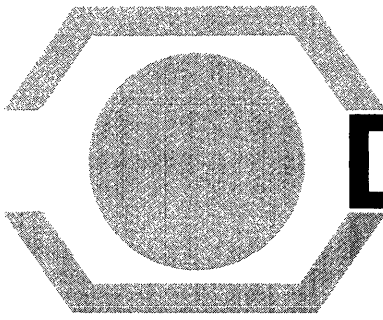

# DECUSCOPE

DIGITAL EQUIPMENT COMPUTER USERS SOCIETY

1966  
Vol. 5 No. 3

## A SOFTWARE STACK SYSTEM FOR THE 340/347 DISPLAY

R.M. Burstall  
and  
J.V. Oldfield

University of Edinburgh, Scotland

The 347 Subroutine Option for the 340 Display allows the use of display subroutines for common features of pictures, reducing the space taken by the display file. Using multi-level subroutines the user can trace back through the display file. For example, when the light pen sees a common feature of a picture, the operator may trace back through the display file to the display subroutine of which it is a part and further back through a nest of subroutines.

When entering the display subroutine by the DJS instructions, the ASR (address save register) is loaded with the contents of the program counter plus 1, permitting the user to directly identify the calling program. However, we cannot trace back any further because of the mode system. This difficulty can be solved with a hardware pushdown stack (as in the Type 338 Display), or by interrupting the computer to do the same thing by program. The following method makes use of the limited repertoire of instructions for the display without interrupting the computer.

In multi-level subroutines, the contents of the ASR must be deposited in a store location using the DDS instruction. The subroutine ends with a display jump (DJP) to that location. To use the stack system, certain conventions about the layout of display routines are necessary.

Immediately after the DDS instruction the DJS DOWN instruction must be inserted. This is an entry to the stack system. Prior to exit, a corresponding DJP UP is made. DOWN records at the appropriate stack level and sets the registers DOWN and UP for the next entry. UP merely alters DOWN and UP for the next entry.

The number of stack levels must be determined in advance and corresponding programs must be provided. When identifying the display routines it is useful to associate a leader block with each display subroutine as follows:

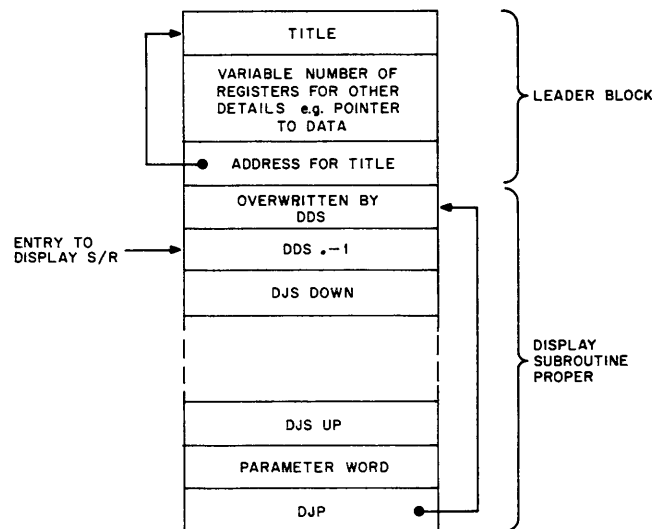

This scheme makes it easier to give the titles of the series of display subroutines involved.

The program for a 3-level stack is as follows:



SET,	360 000 LASTD 760 000 SETA	/DDS /DJS: PUTS DJP DOWN1 IN ASR
DOWN1,	160 000 360 000 LASTD 360 000 STACK1 760 000 DOWA1	/PARAMETER /DDS: DEPOSITS RETURN JUMP /DDS: SETS STACK1 /DJS: PUTS DJP DOWN2 IN ASR
DOWN2,	160 000 360 000 LASTD 360 000 STACK2 760 000 DOWA2	
DOWN3,	160 000 360 000 LASTD 360 000 STACK3 760 000 DOWA3	
	160 000 400 000 ERRLOW	/DJP TO DISPLAY SUITABLE MESSAGE /(BOTTOM OF STACK)
SETA,	360 000 DOWN 760 000 SETUP	/DDS: PUTS DJP DOWN1 IN DOWN /DJS TO SET UP
	160 000 400 000 ERRHI	/DJP TO DISPLAY SUITABLE MESSAGE /(TOP OF STACK)
DOWA1,	360 000 DOWN 760 000 SETUP 160 000 400 000 UP1	/DDS: PUTS DJP DOWN2 IN DOWN /DJS TO PLACE A DJP TO NEXT LOCATION IN UP
DOWA2,	360 000 DOWN 760 000 SETUP 160 000 400 000 UP2	
DOWA3,	360 000 DOWN 760 000 SETUP 160 000 400 000 UP3	
SETUP, LASTD,	360 000 UP 0	/DDS: SETS UP /OVERWRITTEN BY RETURN JUMP
UP3,	160 000 360 000 LASTU 760 000 UPA3	/DDS: DEPOSITS RETURN JUMP
UP2,	160 000 360 000 LASTU 760 000 UPA2	
UP1,	160 000 360 000 LASTU 760 000 UPA1	
	160 000 400 000 ERRHI	/DJP TO DISPLAY SUITABLE MESSAGE /(TOP OF STACK)
UPA3,	300 000 UP 760 000 SETDWN 160 000 400 000 DOWN3	/DDS: PUTS DJP UP2 IN UP

```

UPA2,      360 000 UP
           760 000 SETDWN
           160 000
           400 000 DOWN2

UPA1,      360 000 UP
           760 000 SETDWN
           160 000
           400 000 DOWN1

SETDWN,    360 000 DOWN      /DDS SETTING DOWN
LASTU,     0                  /OVERWRITTEN BY RETURN JUMP

DOWN,
UP,
STACK1
STACK2
STACK3

```

The following is an example of how the stack works. Note that the stack is initialized by a call "DJS SET."

CALLING PROGRAM		Register Contents After Each Instruction is Obeyed					DEPTH
		DOWN	UP	STACK 1	STACK 2	STACK 3	
START,	DJS SET parameter	DJP DOWN1	DJP SETA+2				0
C1,	DJS DOWN	DJP DOWN2	DJP DOWA1+2	DJP C1+1			1
C2,	DJS DOWN	DJP DOWN3	DJP DOWN2+2	DJP C1+1	DJP C2+1		2
C3,	DJS DOWN	DJP DOWN3+4	DJP DOWA3+2	DJP C1+1	DJP C2+1	DJP C3+1	3
	DJS UP	DJP UPA3+2	DJP UP2	DJP C1+1	DJP C2+1	DJP C3+1	2
	DJS UP	DJP UPA2+2	DJP UP1	DJP C1+1	DJP C2+1	DJP C3+1	1
C4,	DJS DOWN	DJP DOWN3	DJP DOWA2+2	DJP C1+1	DJP C2+1	DJP C3+1	2
	DJS UP	DJP UPA2+2	DJP UP1	DJP C1+1	DJP C2+1	DJP C3+1	1
	DJS UP	DJP UPA1+2	DJP UP2+3	DJP C1+1	DJP C2+1	DJP C3+1	0
	DJS UP	ERROR					-1

# NEW ITEMS

## DECUS MEMBER TO SPEAK AT SECOND INTERNATIONAL CONGRESS

DECUS member, Dr. Ian E. Bush of the Worcester Foundation for Experimental Biology, will be giving a paper entitled, "Development of Automated Method for Large-Number Steroid Analyses", at the Second International Congress in Milan, Italy, during the latter part of May. The computer to be discussed in his paper is the PDP-8.

## DIGITAL PROGRAM LIBRARY NOTE

Digital Equipment Corporation presently supports two library programs, Digital Program Library and DECUS Program Library.

The Digital Program Library contains programs written by DEC and normally shipped with the computers. Also included is literature on the standard compilers and assemblers; utility, debugging, and I/O routines; mathematical subroutines; and maintenance and diagnostic programs.

Programs in the DECUS library are received from users, and this library is maintained by the users group. Changes and additions are announced monthly in DECUSCOPE.

The Digital Program Library now plans to issue a newsletter also, and is now preparing a mailing list. Any DECUS member interested in receiving this newsletter as well as DECUSCOPE please complete the enclosed card and return it to Joan Cowles, Digital Program Library.

## EQUIPMENT AVAILABLE

### Refurbished Units Available from DEC

The Field Service Department of Digital Equipment Corporation has available three IBM Model B Computer-Writers (the type used on the PDP-1), and a Type 50 Magnetic Tape Transport with Type 51 Control. These units have been completely overhauled and the prices reduced considerably. Anyone interested in purchasing these units should contact Jack Shields at Digital Equipment Corporation, Maynard, Mass.

## EDITOR'S NOTE

DECUS readers who wish to buy or sell new or used equipment are invited to place a notice in DECUSCOPE. Notices should be sent to the DECUS Executive Secretary, DECUS, Maynard, Mass., and should include the name of the person to be contacted. At present there is no charge for the publication of these notices.

## DECUS EUROPEAN SEMINAR

The DECUS European Seminar is to be held at the Washington Hotel, Curzon Street, London, England, on Wednesday and Thursday, April 27 and 28. The registration fee is two guineas (\$6.00). A Seminar dinner will be held on Wednesday evening at 7:00 p.m. The following participating installations have announced discussion topics:

- PDP-4/7 University of Delft - Control Engineering Problems  
Harwell - Precision Display as FORTRAN On-Line Printer  
Manchester University - Van-de-Graaff On-Line Computer Facilities  
Oxford University - CORAL On-Line Time-Sharing System
- PDP-5/8 Royal Dutch Blast Furnaces - On-Line Steel Sample Analysis  
A.E.C. Denmark - System Description
- PDP-6 University of Aachen - On-Line Connection of Several Machines

## PHYSICISTS AT UNIVERSITY OF FREIBURG TO USE PDP-8 COMPUTER IN BEAM STUDIES

The Physics Department of the University of Freiburg will use a PDP-8 on-line in experiments with one or two molecular beam machines.

The machines generate two beams of neutral particles (or one charged beam) which pass with thermal velocity through a vacuum. At the crossing point of the beams, the atoms scattering events will provide knowledge about the atomic forces between the particles.

In these experiments, the PDP-8 will serve three functions: as a limit control in selecting the velocity of the molecular beam; as an automatic switch and actuator for beam flags; and simultaneously, as an automatic data acquisition system. It replaces an older fixed-program device.

The PDP-8 for Freiburg includes the basic 4096-word core memory and two teleprinters. An interface between the computer and the beam machines is being built at the university with FLIP CHIP modules and accessories supplied by Digital. The interface will include buffer registers and a crystal-controlled clock.

"In this low frequency region," Dr. Naumann said, "We can see the motion of an entire macromolecular chain--motion involving the oscillation of one chain against another chain. In this way we are able to see the vibration of a hydrogen bond, for example, directly. All such vibrations are sensitive to how a particular chain is oriented in the surrounding material, and to how it is packed in the material; that is, how the chains are oriented with regard to each other. The vibrations also are sensitive to any changes of hydrogen bonding that may occur. By studying such motions we are able to gain some insight into how these factors, among others, play a role from a biological standpoint."

"Enough work is found for the computer to keep it busy virtually 24 hours a day," Dr. Safford said. In addition to its on-line assignments with the nuclear reactor, the PDP-5 is used for a variety of general computational work. This is significant advantage over having a machine that functions only as a Multianalyzer, since the production of neutrons for time-of-flight studies represents only a small portion of the work done by the nuclear reactor itself.

#### GEODETIC SURVEY SHIP WHITING WILL USE PDP-8 TO PLOT DATA

More efficient, rapid collection of hydrographic data needed for navigation charts is the goal of a computer-based system being developed by the Coast and Geodetic Survey for the ship WHITING, using a PDP-8.

The system will compute angular, range, or hyperbolic navigation data and maintain a track plot on which ocean depths will be entered automatically at specified intervals on surveys extending up to 100 miles from shore.

The Coast and Geodetic Survey is a part of the U.S. Department of Commerce's Environmental Science Services Administration. A principal mission of its survey fleet, including the WHITING, is to investigate and chart coastal waters for the safety of commercial and pleasure craft.

Survey techniques, many of them pioneered by the agency and made possible by equipment it has developed during its 125-year history, include depth measurement, determination of temperature, salinity, density, and water and bottom sampling. Much of the data from these studies has been taken in digital form for processing ashore. The PDP-8-based system aboard the WHITING will permit on-site decision making, and more rapid automatic chart plotting.

Along with the PDP-8, the system will include a 8192-word core memory, heavy-duty on-line teleprinter, high-speed paper tape reader and control, real-time clock, input buffer for a binary-coded-decimal data interface, flatbed x-y plotter, sextant data interface with relays for bell or gong signals, an interface for computer diagnostic warning signal, and a heading change meter.

#### PDP MULTIANALYZER IN TIME-OF-FLIGHT AND PULSE HEIGHT STUDIES

The Australian Atomic Energy Commission will use a PDP Multianalyzer built on a PDP-7 computer in the Physics Division of Lucas Heights Laboratories.

Working with the Commission's Moata nuclear reactor, a new 3 MeV Van de Graaff positive ion accelerator, and other radiation sources, it will perform time-of-flight and pulse-height studies.

The Physics Division examines the fission process, nuclear properties of heavy elements, and neutron physics information for use by reactor designers.

Included with the PDP-7 computer in the multianalyzer is a 4096-word core memory, paper tape reader and punch, dual analog-to-digital converters, a CRT display which presents results of the analyses graphically, and special Digital programs to perform the main data analysis functions.

#### PDP-8 CONTROLS TRACKING IN RADC RADAR PROGRAM

The Space Surveillance and Control Division of Rome, N.Y., Air Development Center is using a PDP-8 computer as the heart of a target tracking system in its radar techniques development program. It is being used with a bistatic system called ASFIR (Active Swept Frequency Interferometer Radar).

The computer receives data representing range and range difference from master and slave sites, solves equations to derive azimuth and elevation angles, and compares this pure target information with shaft angle readings generated by the antenna pedestals to determine target velocity. The velocity data is then used to generate signals correcting the antenna positions, thus closing the feedback control loop.

In addition to the basic PDP-8 with 4096-word core memory, console teleprinter, and standard in/out provisions, the Rome computer includes a multiplexed analog-to-digital converter, a 300-character-per-second perforated tape reader, and a CRT display. The interface between computer and radars is built with Digital's FLIP CHIP modules.

#### COMPUTER PLAYS CATCH WITH NEUTRONS TO MEASURE FORCES AT WORK IN MATTER

Tuxedo, N.Y.--Scientists at the Union Carbide Sterling Forest Research Center are using an electronic computer as a super stop watch in an effort to probe some of the basic forces at work in liquids and solids.

Working with a privately owned nuclear reactor in a remote sylvan setting about 40 miles from New York, the Union Carbide scientists are timing and counting low energy (cold) neutrons which have collided with samples of matter. The targets for the flying sub-atomic particles range from nylon to the artificial polynucleotides which are related to the basic chemicals of life.

The problems under investigation are of both fundamental and practical concern to Union Carbide and to the customers who make use of the company's nuclear research facilities. "By looking at the basics," says Dr. George J. Safford, research physicist at the site, "we hope to gather information which will ultimately help to produce better polymers, suggest improved applications of existing materials, and perhaps discover how certain vibrations in a macromolecule affect the biological role of RNA or DNA, or perhaps simply help to

produce a specific type of graphite. In addition, we are gathering fundamental information on the structure of water and salt solutions under the auspices of the Office of Saline Water; such data are important in understanding and improving the desalination processes."

The computer being used to time the flying neutrons is a general-purpose Digital PDP-5, with what Dr. Safford describes as a "time-of-flight front end" especially built into it by its maker, DEC. Technically known as a Multianalyzer, the computer and its accessories track neutrons along a known flight path after they have been used to bombard the sample matter in the target area. By determining the final velocity of the neutrons, the scientists can determine what energy was gained from the target sample, and thus investigate the forces at work in the substance under study.

"The PDP-5 is used to study the forces and molecular structure in our samples in their solid or liquid states, discover what they are and how they relate, and in this way investigate the structural chemistry involved," Dr. Safford said.

The neutron beams that irradiate the samples come from Union Carbide's research reactor, a 5-megawatt "swimming pool" reactor whose fuel elements are enriched uranium-235. The reactor, heart of the corporation's private nuclear research programs, performs varied tasks for Union Carbide and the many companies which make use of this facility. For instance, the reactor has enabled Union Carbide to become one of the prime producers of isotopes for medical diagnostic uses. The proximity to New York airports permits shipment of "short-lived" isotopes to almost anywhere in the country. These isotopes are especially important since they decay quickly and give the patient a minimal radiation dose. New materials, such as strontium-87m for diagnosis of bone tumors, are continually being developed. The reactor neutrons are also being used as an analytical tool in another biomedical application. Neutron activation analysis is being used to determine the importance of trace elements on health and disease.

The neutron-timing activities of the laboratory start with the production of a monochromatic beam of neutrons from the reactor core, suspended some 25 feet beneath the surface of the containing pool. With the high-energy neutrons removed by a low-pass filter, the remaining particles bombard the sample under study, contained in a shielded turret. Having picked up energy from the vibrational motions of their target, the neutrons are scattered in all directions.

Only those neutrons proceeding down the predetermined nuclear race track are timed and counted, after being cut into sharp bursts of energy by a neutron "chopper"--actually a gate of rotating slits which whirl around at 7,000 rpm.

The experimenters' clock is a crystal oscillator which "ticks" every 28 microseconds. After 256 of these cycles, the timer returns to zero and waits for the next burst of neutrons before it begins oscillating again.

The neutron counter itself is an aluminum tube filled with boron trifluoride. Some 90% of the boron is in the form of the isotope, boron 10. When the enriched boron is struck by a neutron, an alpha particle plus an atom of lithium are liberated. The charged particles ionize the gas in the tube and create a pulse which can be recorded.

The counter is divided into four independent scalers. Each of the four divisions may be read in "real time," without stopping the scaler, a feature which eliminates the cumbersome correction steps required for systems which halt the scaler to read it.

"We've been given a high degree of versatility by this arrangement of the PDP-5's time-of-flight front end," said Dr. Safford. "We have a choice of the number of cycles, from 4 to 256, over which to spread the spectrum. And the oscillator period can vary from 4 to 64 microseconds continuously.

"This is a distinct advantage. The variable width of the cycles means that channel width is no longer a limiting factor in resolution. And the versatility of being able to select the total number of channels enables us to spread out our time to the maximum degree."

As each experiment proceeds, the data are stored in memory of the computer, which immediately begins to manipulate the information according to program. Readout is provided on tape, and the Union Carbide scientists are able to play back the experiment, stop at any point for detailed study, or put the tape aside for future use. While the experiment is in progress, they are also able to follow developments as they happen on the PDP-5's oscilloscope.

Use of a general-purpose computer like the PDP-5 for this work is a comparatively recent development. Previously, fixed-purpose devices had been in widespread use in similar research programs.

Among other investigations in recent months, the group has been studying the properties of various elastomers and of biological macromolecules; particularly the artificial RNAs which fall under the heading of "polynucleotides."

"We look at very low frequency molecular motions and get data of the type obtained by infrared and Raman spectroscopy, but in a much lower frequency region," said Dr. Wayne Naumann, a Union Carbide physical chemist associated with Dr. Safford in the research.

## DECUS PROGRAM LIBRARY

### PDP-5/8 PROGRAM LIBRARY ADDITIONS

#### DECUS No. 5-34

Title: Memory Halt - A PDP-5 Program to Store Halt in Most of Memory

Author: P. T. Brady, New York University, Bronx, New York

With Memory Halt and OPAK, (DECUS No. 5-2.1), in memory, it is possible to store halt (7402) in the following memory locations:

0001 to 0005  
0007 to 6177  
7402 and 7403

Memory Halt occupies locations 0200 to 0237 with a starting address of 0200. When started, it stores 7402 in locations 0001 to 0005 and locations 7402 and 7403. It then sets up some memory location so that OPAK can store 7402 in locations 0007 to 6177.

Halts in memory are useful when a program transfers control to an area of memory not occupied by the program itself. Upon executing the JMP or JMS instruction, the computer halts. With careful investigation, the programmer can determine why the transfer of control took place.

#### DECUS No. 5/8-35

Title: Binary Coded Decimal to Binary Conversion Subroutine and Binary to Binary Coded Decimal Subroutine (Double Precision)

Author: Selene H.C. Weise, Bermuda Press, Limited, Hamilton, Bermuda

This program consists of a pair of relatively simple and straightforward double-precision conversions. They make no claim to speed or brevity. A double entry has been used which is:

TAD High  
JMS BCD Bin  
TAD Low  
JMS BCD Bin+3

#### DECUS No. 5-36

Title: Octal Memory Dump Revised

Author: Paul Hammond, Woods Hole Oceanographic Institution, Woods Hole, Massachusetts

The Octal Memory Dump on Teletype is a DEC routine (DEC-5-8-U) which dumps memory by reading the switch register twice; once for a lower limit and again for an upper limit.

It then types an address, the contents of the program and the next three locations, issues a CR/LF, then repeats the process for the next four locations. This leaves the right two-thirds of the Teletype page unused. The 78<sub>10</sub> instructions occupy two pages.

This revised routine uses the complete width of the Teletype page and occupies only one memory page, using less paper and two less instructions. Now an address and the contents of 15 locations are typed out before a carriage return.

Octal Memory Dump Revised has proved its value as a subroutine and/or a self-contained dump program when it is necessary to dump large sections of DECTape, magnetic tape (IBM compatible), or a binary formatted paper tape.

#### DECUS No. 5-37

Title: Transfer II

Author: Paul Hammond, Woods Hole Oceanographic Institution, Woods Hole, Massachusetts

For users who have more than one memory bank attached to the PDP-5/8, Transfer II may prove valuable in moving information from one field to another. Often areas designated for loaders are being used for other reasons, only to find the loaders necessary a few minutes later. When debugging, Transfer II enables a programmer to make a few changes in a new program and test it without reading in the original program again, especially if his corrections did not work. In short, Transfer II enables more extensive use of memory banks.

## NEW DECUS MEMBERS

### PDP-1 DELEGATE

Lt. Willie D. Cowan  
6570 Aerospace Medical Research Laboratories  
Mathematics & Analysis Branch (MRBAM)  
Wright-Patterson AFB, Ohio

Lt. Cowan replaces Capt. John Alexander

### PDP-4 DELEGATE

James C. Taliano  
Wheeling Steel Corporation  
Steubenville, Ohio

### PDP-5 DELEGATE

Joseph Rudman  
Carnegie Institute of Technology  
Pittsburgh, Pennsylvania

Mr. Rudman replaces Mr. S. Stasak

### PDP-7 DELEGATES

P. M. Clothier  
Data Processing Group  
National Gas Turbine Establishment  
Pyestock, Hampshire, England

Hans-Jurgen Trebst  
Physics Institute  
University of Erlangen  
Erlangen, Germany

### PDP-8 DELEGATES

George A. Bradfute, Jr.  
Cardio-Pulmonary Laboratory  
Baptist Memorial Hospital  
Memphis, Tennessee

Ian E. Bush  
Worcester Foundation For Experimental  
Biology  
Shrewsbury, Massachusetts

John J. Byrnes  
Systems Research Laboratories, Inc.  
Manhattan Beach, California

Gerald Dolling  
Atomic Energy of Canada Ltd.  
Neutron Physics Branch  
Chalk River, Ontario, Canada

R. C. Drechsler  
Bell Telephone Laboratories, Inc.  
Murray Hill, New Jersey

L. Gerald Firth, Jr.  
Data-Master Division  
Bristol Company  
Glen Cove, New York

Jerry M. Friedman  
Brookhaven National Laboratory  
Applied Mathematics Department  
Upton, New York

J. C. Holmes  
Motorola, Inc.  
Phoenix, Arizona

Helmut Karl  
Physics Institute  
University of Aachen  
Aachen, West Germany

James D. Salmon  
George Kents Ltd.  
Luton, Bedfordshire, England

PDP-8 DELEGATES (Continued)

Richard S. Ward  
American-Standard Research Division  
New Brunswick, New Jersey

LINC DELEGATES

Norman A. Coulter  
The University of North Carolina  
School of Medicine  
Chapel Hill, North Carolina

Allan M. Schrier  
Primate Behavior Laboratory  
Brown University  
Providence, Rhode Island

Howard M. Yanof  
Saint Louis University  
Medical Center Computer Laboratory  
Saint Louis, Missouri

DISPLAY DELEGATE

H. G. Tremblay  
Computer-Simulation Division  
U. S. Naval Air Development Center  
Johnsville, Warminster, Pennsylvania

INDIVIDUAL MEMBERS

Carl Aaron, Jr.  
Lawrence Radiation Laboratory  
Livermore, California

Donald B. Brick  
Information Research Associates, Inc.  
Cambridge, Massachusetts

Walter R. Burrus  
Oak Ridge National Laboratory  
Oak Ridge, Tennessee

John F. Buckley  
Wheeling Steel Corporation  
Steubenville, Ohio

Joseph Cardenia  
ITT Federal Electric Corporation  
c/o AVWS - EDE Group  
Wright Patterson AFB, Ohio

Robert M. Carmichael  
Lear/Siegler  
Anaheim, California

Charles E. Cole  
Lawrence Radiation Laboratory  
Livermore, California

Donald N. Cornwell  
Atomic Energy of Canada Ltd.  
Reactor Physics II Branch  
Chalk River, Ontario, Canada

Paul F. Coughlin  
Bolt Beranek and Newman Inc.  
Cambridge, Massachusetts

W. A. Cummins  
Information Systems Company  
Los Angeles, California

Edward Glaser  
Neutron Physics Branch  
Atomic Energy of Canada Ltd.  
Chalk River, Ontario, Canada

R. C. Hawkings  
Atomic Energy of Canada  
Chalk River, Ontario, Canada

Michael S. Helfer  
New York University  
Bronx, New York

Henry C. Kashian  
Information Research Associates, Inc.  
Cambridge, Massachusetts

Karl Marlinghaus  
Saint Louis University  
Saint Louis, Missouri

David C. Miller  
Massachusetts Institute of Technology  
Cambridge, Massachusetts

John W. Notely  
George Kents Ltd.  
Luton, Bedfordshire, England

Marc Platt  
Brookhaven National Laboratory  
Upton, New York

Alan David Purnell  
Atomic Weapons Research Est.  
Aldermaston, Berkshire, England

Hub S. Ratliff  
International Data Systems  
Houston, Texas

Mary E. Robinson  
Information Research Associates, Inc.  
Cambridge, Massachusetts

Michael Salvato  
Data-Master Division  
Bristol Company  
Glen Cove, New York

Julian M. Scher  
New York University  
Bronx, New York

Thomas E. Schwab  
AFMDC, MDRCP  
Holloman AFB, New Mexico

DECUSCOPE is published monthly for Digital Equipment Computer Users Society (DECUS).

Material for publication should be sent to: Angela J. Cossette, DECUS, Maynard, Massachusetts 01754. Telephone: AC 617 897-8821, TWX 710 347-0212

Publications Chairman: Joseph Lundy, Inforonics, Inc.

Circulation: 1,500 copies per month

DECUS acknowledges the assistance of Digital's Technical Publications Department in the preparation of this newsletter.

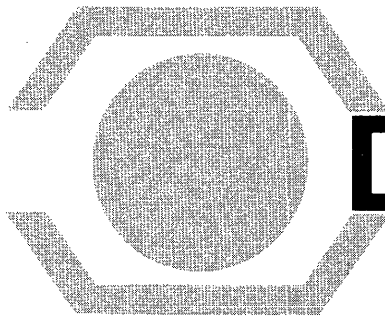

# DECUSCOPE

DIGITAL EQUIPMENT COMPUTER USERS SOCIETY

1966  
Vol. 5 No. 4

## DECUS SPRING SYMPOSIUM Hotel Somerset, Boston, Massachusetts May 23, 24, 25, 1966

The 5th Spring Symposium of Digital Equipment Computer Users Society will be held on May 23, 24, and 25 in the Coronet Room of the Hotel Somerset, Boston, Massachusetts.

Monday, May 23, will be devoted to biomedical applications and will include informal panel discussions on such topics as: laboratory data processing, display techniques, on-line medical record keeping, and patient monitoring. A demonstration of the Hospital Computer Project System at Massachusetts General Hospital has been arranged for later in the afternoon. Abstracts of the papers for presentation are included in this issue.

Tuesday and Wednesday, May 24 and 25, will be devoted to general applications. Abstracts of the papers for presentation are included in the following pages. Registration forms for both biomedical and general sessions have been sent to all DECUS members. Non-members are invited to attend and may request registration forms from the DECUS office or register on the morning of the session which they wish to attend. If you plan to attend, please send in your registration form as soon as possible in order that we may estimate the number of attendees. DECUS symposia are an excellent opportunity for members to actively participate in the users group. We encourage informal gatherings as well as formal attendance during the presentation of papers. Along with the presentation of papers, an informal discussion on PDP-6 software, and a "sound-off" session is also planned. A room will be available for those who wish to gather informally away from the general meeting room. Anyone interested in participating in the PDP-6 software discussion should contact Mr. David Friesen of the Massachusetts Institute of Technology, 575 Technology Square, 4th Floor, Building Alpha, Cambridge, Massachusetts.

Luncheons have been arranged for all three days and dinner and cocktail hour has been arranged for Monday and Tuesday evening. Cocktails are not included in the price of the registration, however, hors d'oeuvres will be provided. The Hotel Somerset is well known for its excellent meals, and attendees are given a varied choice of main courses. Selection of meals may be made on the registration forms. The Somerset has guaranteed reduced room rates for meeting attendees. We will be happy to make reservations for you, however, if you wish to make your own reservations at the

Somerset, please mention that you will be attending the DECUS meeting so that you will be eligible for the reduced room rates of: Single - \$12.00, Double - \$16.00.

The final program will be available in a week or two, however, a tentative agenda follows:

### TENTATIVE AGENDA

#### Biomedical Session - May 23

- |             |   |
|-------------|---|
| 8:30 - 9:15 | Registration  |
| 9:15        | Opening of Meeting<br>Dr. G. Octo Barnett, Chairman   |
| 9:30        | Use of PDP-5 in Analyzing Single Neuron Responses to Pairs of Stimuli<br>David Penner and Paul D. Coleman<br>University of Maryland                                   |
| 10:00       | The PDP-8's Role in the AutoChemist System<br>Dr. Hans Peterson, AB Autokemi (Sweden)   |
| 10:30       | Coffee  |
| 10:45       | Digital Computer Techniques for Testing a Tapered Transmission Line Model of the Human Aorta<br>R. Hilton, S. Fich, and W. Welkowitz<br>Rutgers, The State University |
| 11:15       | Informal Panel Discussion   |
| 12:15       | Lunch   |
| 1:00        | Use of a Non-Procedural Language for Medical Information Retrieval<br>Paul Castleman, Bolt Beranek and Newman   |
| 1:45        | Biomedical Application of an On-Line Interpreter, Neil Pappalardo<br>Massachusetts General Hospital   |
| 2:15        | Informal Panel Discussion   |
| 3:15        | Coffee  |
| 3:30        | Demonstration of the Hospital Computer Project System, Massachusetts General Hospital   |



6:00 - 7:00 Cocktail Hour  
7:00 Dinner - Hotel Somerset

General Session - May 24

9:00 - 10:00 Registration  
10:00 Opening of Meeting  
Professor Donald A. Molony, Chairman  
10:15 Use of a PDP-5 as an Educational Computer  
D. A. Molony, E. Della Torre, and F. Skove  
Rutgers, The State University  
10:45 Application of the PDP-5 to Data Handling  
for Meson Produced X-Rays  
Robert Lafore, Lawrence Radiation Laboratory  
11:15 The PDP-5 as a Satellite Processor  
Paul R. Weinberg and Michael S. Wolfberg  
Moore School of Electrical Engineering  
12:00 Lunch  
1:30 IL-8, Interpreter Language for the PDP-8  
Peter Headly, University of Michigan  
2:00 Utility Programs for the PDP-5 and PDP-8  
Edward Della Torre  
Rutgers, The State University  
2:30 A Functional Description of the LINC-8  
Wesley A. Clark, Washington University  
Richard Clayton, Digital Equipment Corp.  
3:00 Coffee  
3:30 LAP5: LINC Assembly Program  
M. A. Wilkes, Washington University  
4:00 Discussion Sessions:  
PDP-6 Software  
"Sound-Off Session"  
6:00 - 7:00 Cocktail Hour  
7:00 Dinner - Hotel Somerset

General Session - May 25

9:00 - 9:30 Registration (if necessary)  
9:35 Opening of Second Day's Session  
9:45 Computer Aids to the Handicapped - The  
PDP-8 as a Braille Translator  
Henry S. Magnuski, M.I.T.  
10:15 An Adaptive Communications Receiver  
D. C. Coll and J. R. Storey  
Defence Research Telecommunications  
Establishment (Canada)  
10:45 Coffee  
11:00 A Computer Controlled Linear Filter  
J. R. Storey and D. C. Coll  
Defence Research Telecommunications  
Establishment (Canada)  
11:30 PDP-6 On-Line Checking of Bubble  
Chamber Data  
George Krebs, Rutgers-The State Univ.  
12:00 Lunch  
1:30 The Use of a PDP-7 and 340 Display for  
Architectural Design  
W. M. Newman, C.W. Adams Associates  
2:00 Compatible Time Sharing On A Small Computer  
Martin L. Cramer, Electronic Associates Inc.  
2:30 The Combination of On-Line Analysis with  
Collection of Multicomponent Spectra in a  
PDP-7  
R. D. Coffin and N. P. Wilburn  
Battelle-Northwest  
3:00 Coffee  
3:30 Discussion Session - DECUS Software Policies

## ABSTRACTS

### BIOMEDICAL SESSIONS

#### USE OF PDP-5 COMPUTER IN ANALYZING SINGLE NEURON RESPONSES TO PAIRS OF STIMULI

David Penner  
Paul D. Coleman  
University of Maryland  
School of Medicine  
Baltimore, Maryland

This paper describes programs and interface used to study electrical responses of single neurons to pairs of stimuli derived from a PDP-5 computer. The PDP-5 controls both the time delay between stimuli in a pair and the relative intensities of the stimuli in a pair. Signals recorded by a microelectrodes are examined for presence of a response. After a planned sequence of stimuli has been completed, a scan (raster) of post-stimulus time histograms for all values of the stimulus parameter is presented on an oscilloscope. The

operator determines portions of the histograms for summing neuron responses and latency measures. The computer then types out these measures and graphs them on an oscilloscope as a function of stimulus parameter.

#### THE PDP-8'S ROLE IN THE AUTOCHEMIST SYSTEM

Dr. Hans Peterson  
AB Autokemi  
Stockholm, Sweden

The AutoChemist, an apparatus designed for mass chemical analysis in the hospital laboratory, uses the PDP-8 in both on-line and off-line operation.

The large capacity of the AutoChemist, more than 3000 analyses per hour, necessitates a flexible data acquisition, processing, and storage system operating on line as well as the means, particularly in research and health screening applications, to draw statistical conclusions from the data acquired.

## DIGITAL COMPUTER TECHNIQUES FOR TESTING A TAPERED TRANSMISSION LINE MODEL OF THE HUMAN AORTA

R. Hilton  
S. Fich  
W. Welkowitz  
Rutgers, The State University  
Department of Electrical Engineering  
New Brunswick, New Jersey

The problem is to test a tapered transmission line model of the human aorta. The model equations are written in the complex frequency domain, while the behavior of the real aorta is known in terms of time domain phenomena. The DEC PDP-5 is used in conjunction with tables of functions generated on the IBM 7040 to do Fourier analysis of the input waveforms and to reconstruct the output waveforms with graphical presentation of the results.

## USE OF A NON-PROCEDURAL LANGUAGE FOR MEDICAL INFORMATION RETRIEVAL

Paul A. Castleman  
Bolt, Beranek and Newman, Inc.  
Cambridge, Massachusetts

The presentation will describe the medical information retrieval system developed by the Hospital Computer Project. Emphasis will be placed on the non-procedural question (by computer) and answer (by the user) type language used to specify a file, put data into the file, and retrieve information from the file. The careful human engineering necessary for the non-programmer user will be described.

The latter portion of the presentation will be devoted to an analysis of the virtues and vices of a non-procedural language, and the types of situations which are both easy and difficult to handle.

## BIOMEDICAL APPLICATIONS OF AN ON-LINE INTERPRETER

A. Neil Pappalardo  
Research Computer Center  
Massachusetts General Hospital  
Boston, Massachusetts

JOSS, originally developed by J. C. Shaw, Rand Corporation, is an on-line mathematical interpreter. It is used either to perform individual mathematical manipulations or to express an algorithm by a sequence of mathematical manipulations. A time-sharing version of JOSS, called TEL-COMP, has been developed by Bolt Beranek and Newman, Inc., and is presently being used at the Massachusetts General Hospital to solve various problems originating at the Research Laboratories. An expanded version, JOSS-7, is being developed at Massachusetts General Hospital for the PDP-7 computer. This version will utilize the A-D converter, the display scope, and the digital plotter to provide a convenient and versatile tool to solve on-line and real-time problems. Both versions will be described and their biomedical applications discussed.

## GENERAL SESSION

### THE USE OF A PDP-5 AS AN EDUCATIONAL COMPUTER

D.A. Molony  
E. Della Torre  
F. Skove  
Rutgers - The State University  
New Brunswick, New Jersey

The experiences in the use of a PDP-5 as an educational computer in the Computer Laboratory of the Department of Electrical Engineering at Rutgers are described.

Special instructional programs that allow for rapid familiarization with basic operation and elementary programming in machine language are discussed. The use of the PDP-5 in conjunction with existing analog computers as an elementary hybrid computer for instructional and other purposes is considered.

### APPLICATION OF THE PDP-5 TO DATA HANDLING FOR MESON PRODUCED X-RAYS

Robert Lafore  
University of California  
Lawrence Radiation Laboratory  
Berkeley, California

This paper describes the application of a PDP-5 to data handling for meson produced x-rays at the LRL Cyclotron. The program receives data from a 4,000-channel A/D converter, stores it on magnetic tape, and provides a scope display (with several ranges) of the data spectrum. In addition the program provides feedback to the gain and bias settings of the data amplifier, thus insuring minimum drift during the course of the experiment. Various options are provided to the operator by the Teletype keyboard to alter the main part of the program on line.

### THE PDP-5 AS A SATELITE PROCESSOR\*

Paul R. Weinberg  
Michael S. Wolfberg  
The Moore School of Electrical Engineering  
University of Pennsylvania  
Philadelphia, Pennsylvania

A PDP-5 at the University of Pennsylvania is attached to an IBM 7040 through a high speed data channel. In this configuration it serves as an intermediary between the 7040 and several remote consoles including character displays, Teletypes, and chemical typewriters. The purpose is to provide real-time information retrieval systems with a remote console capability. The interaction among the various subsystems is discussed, and some examples of operation are given. A brief account of the use of the 7040 IBM AP Processor for the assembly of PDP-5 programs is also included.

\*This work was supported by the Rome Air Development Center and by the Office of Naval Research, Information Systems Branch under Contract 551(40) and by the U.S. Army Edgewood Arsenal under Contract DA 18-035-AMC-288(A).

## IL-8 INTERPRETER LANGUAGE FOR THE PDP-8

Peter Headly  
Mental Health Research Institute  
University of Michigan

Since the use of a PDP-8 for ordinary data processing involves a large number of subroutines, a natural step is to organize the most common routines into a complete programming system. An IL-8 instruction consists of a command word, which specifies a subroutine, followed by up to three words which contain addresses, parameters, or operands (constants). Address indexing on two index registers is also coded in the command word. Instructions are executed by means of a highly interdependent set of subroutines contained in the IL-8 interpreter (first seven pages of core).

IL-8 obviates the special problems of PDP-8 programming:

- 1) inability to directly address "off-page" locations
- 2) puny instructions
- 3) small word size

The last problem is corrected by providing single, double, and triple precision options for logical, arithmetic, rotation, and comparison instructions.

Generally speaking, the system endows the PDP-8 with characteristics of much larger computers. The IL-8 assembler, itself an IL-8 program, demonstrates a very reasonable operating speed and also the fact that IL-8 is conservative of memory. The assembler provides for use of literals and constants specified in decimal (single, double, and triple precision), octal, or ASCII, and allows the coding of variable length ASCII constants (either one character per word or trimmed code).

### UTILITY PROGRAMS FOR PDP-5/8 COMPUTERS

Edward Della Torre  
Department of Electrical Engineering  
Rutgers - The State University  
New Brunswick, New Jersey

The purpose of these programs is to facilitate handling punched paper tape used with PDP-5/8 computers. They are designed for editing symbolic and binary tapes and presenting the printed copy in a more convenient format.

To edit symbolic tape they must be placed on the high speed reader. Then under Teletype control they are copied with lines inserted or omitted as desired. A control tape may be prepared so that editing can be done automatically.

One of the programs removes non-printing symbols that are inadvertently added to symbolic tapes, so that the first tape will be free of "invisible" illegal characters. Another program breaks up the printed copy of a symbolic tape into page sizes.

In order to edit binary tapes the user first converts them to a symbolic format, henceforth called Q.R. After editing they are converted back to binary tapes. An octal disassembler for binary tapes is included to simplify editing.

## A FUNCTIONAL DESCRIPTION OF THE LINC-8

Wesley A. Clark  
Washington University  
St. Louis, Missouri

and

Richard Clayton  
Digital Equipment Corporation  
Maynard, Massachusetts

The LINC-8 consists of a basic PDP-8 supplemented by a hardware subsystem which incorporates most of the register and control logic required in the classic LINC. There are 2048 words of the PDP-8 memory assigned to this subsystem for LINC programs, and an additional 1024 words hold an interpretive PDP-8 program which executes subroutines for operation of the LINC magnetic tape, console, and optional input/output equipment. The organization of the system, the interpretive program, and the use of the data-break and program interrupt facilities for intercommunication will be described.

### LAP5: LINC ASSEMBLY PROGRAM

M.A. Wilkes  
Computer Research Laboratory  
Washington University  
St. Louis, Missouri

LAP5, an on-line assembly program for the 2024-word LINC, uses display scope and keyboard for program preparation. Meta commands for converting and filing programs on the LINC magnetic tapes are described, along with techniques for minimizing tape motion during filing.

Any portion of the source program may be displayed; the memory acts as a window between display scope and magnetic tapes, so that dynamic editing of the information currently displayed, without recourse to special meta commands, is possible. The memory-tape organization to accomplish this is discussed.

### COMPUTER AIDS TO THE HANDICAPPED THE PDP-8 AS A BRAILLE TRANSLATOR

Henry S. Magnuski  
M.I.T.  
Cambridge, Massachusetts

This paper reports on work being done at Project MAC of the Massachusetts Institute of Technology which makes computer translated Braille text available to the blind. A PDP-8 coupled to the Braille equivalent of a Teletype machine has been used to translate English text into Grade 1 and Grade 2 Braille.

The M.I.T. Braille, as it is called, is a machine which can emboss Braille cells at a rate of 10-15 characters per second. This machine, coupled through a special interface on the PDP-8 makes high quality Braille text available to the user of the computer, and to blind users of M.I.T.'s time-sharing

system. The PDP-8 can also be connected to the outside world via a Dataphone link, thus supplying Braille translations from remote locations.

The paper summarizes the above achievements and describes some future plans.

#### AN ADAPTIVE COMMUNICATIONS RECEIVER

D.C. Coll and J.R. Storey  
Defense Research Telecommunications Establishment  
Defense Research Board  
Ottawa, Ontario

An adaptive communication receiver has been synthesized at the Canadian Defense Research Telecommunications Establishment with a hybrid arrangement of analog components, digital modules, and a PDP-5 computer. The receiver is a practical realization of the theoretically optimum system for the reception of time-dispersed, overlapped, pulse signals.

An automatic procedure has been evolved whereby the receiver response is changed in a systematic manner by a PDP-5 to continuously optimize performance as the communication conditions change.

#### A COMPUTER CONTROLLED LINEAR FILTER

J.R. Storey and D.C. Coll  
Defense Research Telecommunications Establishment  
Defense Research Board  
Ottawa, Ontario

Linear filtering of signals is a common requirement in signal processing. This paper describes a filter based on an accumulating multiplier of novel design. The filter is constructed of integrated circuits. The impulse response of the filter may be specified at 32 points, with a 12-bit accuracy under the control of a PDP-5 computer.

Real-time filtering may be performed on input signals that have been sampled at rates of up to 40,000 samples per second.

#### COMPATIBLE TIME-SHARING ON A SMALL COMPUTER

Martin L. Cramer  
Advance Development Department  
Electronic Associates, Inc.  
Princeton, New Jersey

An aim of Project MAC's CTSS was to create a hardware environment in which already existing user and system programs could be run successfully in time-shared mode without major modifications.

A minimum storage time-sharing executive has been designed and implemented which demonstrates this same capability on a standard PDP-7 with an additional Teletype interfaced. The computer's memory is partitioned and the I/O units (paper tape reader, punch, keyboard(s), and teleprinter(s)) are activated with the user's input/output coding sequences essentially unchanged. The monitor's efficient switching algorithm is the classic one based on input/output activity and a fixed, timed interval. The result is a true "open"

time-sharing system which has been demonstrated with two terminals using the full capabilities of DDT, including dual program load, punch, modification and execution with breakpointing.

A pertinent discussion of the limitations of such a time-sharing scheme is included.

#### PDP-6 ON-LINE CHECKING OF BUBBLE CHAMBER DATA

George Krebs  
Rutgers - The State University  
New Brunswick, New Jersey

A 16K PDP-6 system performing on-line checking and processing of bubble chamber data for four measuring machines has been in operation since June, 1965. After all required checks are satisfied, the data is written on an incremental magnetic tape recorder. With an additional 16K of core memory and using the new FORTRAN IV compiler, on-line spatial reconstruction and kinematics will also be implemented. All of the above are in conjunction with the simultaneous use of the standard PDP-6 time-sharing software.

#### THE USE OF A PDP-7/340 DISPLAY FOR ARCHITECTURAL DESIGN

W. M. Newman\*  
C. W. Adams Associates, Inc.  
Cambridge, Massachusetts

A short film will be shown of the use of a computer-driven display to assist in designing modular unit-construction buildings. A program was written using the light pen to allow an architect to build a design from a range of units including walls, doors, windows, etc. As the units are added to the plan they are automatically aligned with the modular grid enabling the architect to sketch a design at great speed. The computer can then evaluate areas of rooms and perform other calculations, displaying the results on the screen.

\*This work was carried out while the author was with Imperial College of Science and Technology, London.

#### THE COMBINATION OF ON-LINE ANALYSIS WITH COLLECTION OF MULTICOMPONENT SPECTRA IN A PDP-7

R. D. Coffin  
N. P. Wilburn  
Battelle-Northwest  
Richland, Washington

A PDP-7 has been interfaced to four Nuclear Data 180-F 256 channel analyzers. All functions of normal multichannel analyzers have been reproduced by suitable coding. In addition, a weighted least-squares method for estimating on line the contribution of individual radionuclides in a multicomponent pulse height spectrum has been incorporated. Details of the mathematics and coding methods used, which include special modifications to the existing FORTRAN system for on-line use, are described.

## A LITTLE BACKGROUND ON THE MEETING CHAIRMEN



G. Octo Barnett, M.D., Director of the Laboratory of Computer Science, Massachusetts General Hospital, is also an established investigator of the American Heart Association; Associate In Medicine, Harvard Medical School; an Assistant in Medicine, Massachusetts General Hospital; Research Associate of the Department of Biology, M.I.T.; and a staff member of the Research Laboratory of Electronics, M.I.T.

Dr. Barnett's major scientific interests include application of digital computers to data analysis and information processing, system analysis of biological control systems, and development of medical instrumentation.

From 1962 to 1964 Dr. Barnett served as Director of the Bioengineering Laboratory, Peter Bent Brigham Hospital. In 1957 and 1958 he was a Research Fellow at Harvard Medical School's Department of Physiology. He also participated in the Cardiovascular Techniques Training Program, University of Washington, and the Section of Clinical Biophysics, National Heart Institute.

His present membership includes the Administrative Committee Professional Group on Engineering in Medicine and Biology, Institute of Electrical and Electronics Engineers; American Federation for Clinical Research; Biophysics Society; American Heart Association; Association for Computing Machinery; New York Academy of Sciences; Circulation Group, American Physiological Society; and Chairman, Gordon Conference on Biomathematics, 1966.

Dr. Barnett holds a B.A. degree (magna cum laude) in chemistry and mathematics from Vanderbilt University, an M.D. degree (magna cum laude) from the Harvard Medical School, and has studied mathematics at the University of Maryland Graduate School and electrical engineering at both the University of Washington Graduate School and M.I.T.



Donald A. Molony, Professor of Electrical Engineering, has been associated with the Department of Electrical Engineering at Rutgers University for 24 years. He has been engaged in research activities in such diverse fields as modulation systems, communication theory, speech analysis and synthesis, high-frequency measurements, micro-wave engineering and acoustics. He is the author or co-author of technical articles or reports in each of these areas.

In 1961 and 1962, Professor Molony was a National Science Foundation Fellow at the "Technical University" in Vienna, Austria. He is a member of the honorary societies, Tau Beta Pi, Eta Kappa Nu, and Sigma Xi, as well as a senior member of the Institute of Electrical and Electronic Engineers.

He has been responsible for the computer laboratory of the Department of Electrical Engineering since its inception and for the teaching program in the area of Electronic Computation of both the graduate and undergraduate levels.

Professor Molony holds B.S. degrees in both Mechanical and Electrical Engineering and a Master of Science degree in Electrical Engineering.

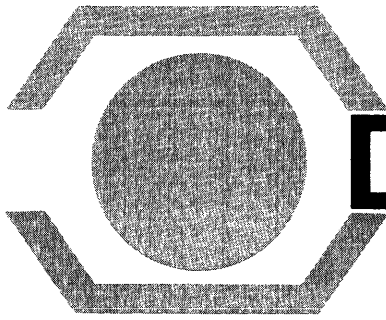

# DECUSCOPE

DIGITAL EQUIPMENT COMPUTER USERS SOCIETY

1966  
Vol. 5 No. 5

## COMPUTER - INTERFACED MULTICHANNEL PULSE - HEIGHT ANALYZER FOR NUCLEAR DATA

Philip R. Bevington  
Stanford University  
Stanford, California

**Abstract:** A circuit for a digital pulse-height analyzer completely constructed from commercially available computer logic and pulse-handling modules, is described. The design combines the reproducible discrimination techniques of conventional analyzers for good differential linearity with a self-correcting successive approximation analog-to-digital converter for high speed and integral linearity.

### Introduction

A preliminary design study has indicated the feasibility and practicality of developing a computer-interfaced multichannel pulse-height analyzer for nuclear data constructed almost entirely from commercially available computer logic modules. This report describes the design of such an analyzer, superior in linearity and speed, to those presently available, and considerably less expensive.

The circuit utilizes a hybrid technique of successive approximation, modified to permit correction of errors, speed in analysis, and reproducible discrimination through an effective ramp voltage for good differential linearity. The average time for analysis with a 12-bit address (4096 channels) is between 10  $\mu$ sec and 15  $\mu$ sec. The integral linearity should be better than 0.1% over the entire range, and the differential linearity (channel width fluctuation) better than 4% for 12 bits or 1% for 10 bits (1024 channels).

The circuit described includes both a 12-bit analog-to-digital converter (ADC) and a 2-bit multiplexer with linear gates and anticoincidence for multiplexing up to 4 inputs. The total cost of the modules for an analyzer incorporating two C's, each with its multiplexer for dual parameter analysis, is approximately \$3500. This does not include the linear amplifier and discriminator (which are external to the ADC) or the linear delay or pulse stretcher.

### Circuit Functions

Figure 1 shows a block diagram of the circuit including one ADC and one input to the multiplexer. The circuit components follow the conventions of the computer modules available from Digital Equipment Corporation. Output levels are  $-3v$  (1) and  $0v$  (0). Black diamonds represent negative levels and open diamonds represent positive (ground) levels; open triangles represent either positive pulses or positive-going level changes. Small rectangles with black triangles are inverters; small rectangles with crosses are pulse gates for delays or binaries (flip-flops), which are enabled by a coincidence between a positive level and a positive pulse.

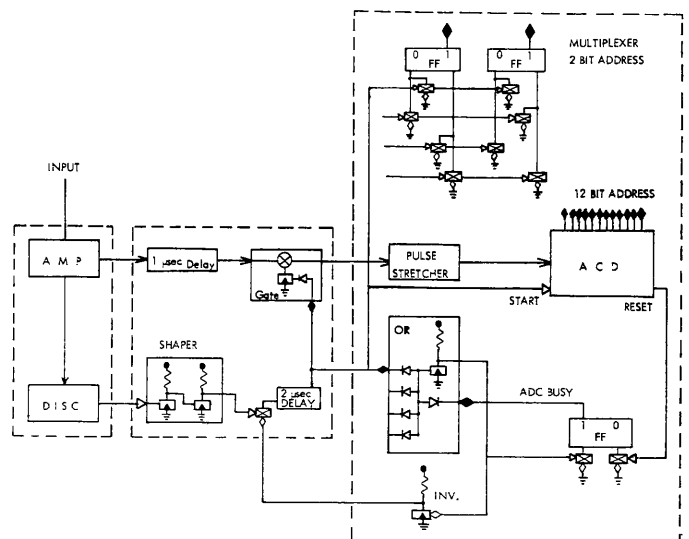

Figure 1

It is assumed that the analog pulse to be analyzed has been amplified externally (between 0v and 10v positive) and that a discriminator pulse ( $>3v$  positive) is available. These units are indicated in the left dotted box of figure 1 but are not a part of the analyzer.

The analog pulse is delayed 1  $\mu$ sec to allow time for the discriminator. If no other analog pulse is present or being analyzed, the discriminator pulse opens the linear gate (multiplexer switch) and transfers the analog pulse to the pulse stretcher. The middle dotted box in figure 1 must be supplied for each multiplexed input.

The pulse stretcher charges up to the maximum height of the input analog pulse and holds this level for the ADC. Meanwhile, the discriminator output has initiated a START pulse to the ADC and set the ADC BUSY binary, which holds all linear gates closed until the ADC has completed its analysis and transfer to the computer memory.

### Analog-to-Digital Converter

Operation: The principle of operation of the ADC is as follows: Figure 2 depicts the schematic for a 4-bit converter. The expansion to a 12-bit converter is by replication between the second and third bits.

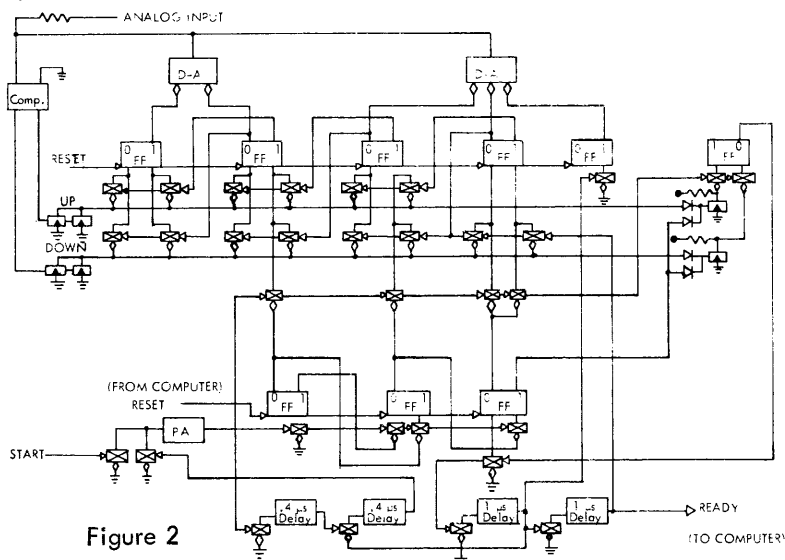

Figure 2

The arrival of a START pulse at the pulse amplifier initiates a train of pulses separated by .8  $\mu$ sec and generated by the two .4  $\mu$ sec delays in series. These pulses successively set the bits of the digital-to-analog converter (DAC) (top row of binaries), starting with the most significant, to approximate the analog input voltage. The step counter (SC) (bottom row of binaries) enables only one bit in the DAC to be set at a time, and each succeeding pulse advances this enabling status to the next more insignificant bit.

If the analog input is greater than the DAC output voltage at the time one bit is being set (transition from 0 to 1 of the corresponding binary), the up level is enabled and only that bit is set. If the analog input is less than the DAC output, the down level is enabled and the DAC acts as a down counter. That is, the next more significant bit is complemented, this action being propagated to the nearest binary in the 1 state. Normally, the analog input is less than the DAC output only if the next more significant bit has previously been set to 1, consequently only that bit is reset. Initially, the most significant bit is already in the 1 state.

When the step counter reaches the least significant bit, the corresponding binary in the SC is not reset by succeeding pulses. Then the DAC seeks the proper output voltage (equal to the analog input) in steps of voltages corresponding to the least significant bit. Presumably, the successive approximation technique results in a setting of the DAC very close to the correct voltage. During this searching procedure, the DAC functions as a true up-down counter, increasing or de-

creasing its count by one, depending on whether the analog input is greater or less than the output voltage.

In this mode, as soon as the DAC counts down, the far right binary is set to 1. When the DAC subsequently counts up, this binary is reset to 0, resetting the last binary in the SC and triggering the first 1  $\mu$ sec delay. This terminates the succession of pulses from the pulse amplifier and stops the searching action of the DAC.

At the end of the 1  $\mu$ sec delay, the 13th bit, having been enabled throughout, is reset, and the second 1  $\mu$ sec delay is triggered. At the end of this second delay, the final decision is made for approximating the analog input with the DAC. If the analog input is larger than the output voltage, the setting is not changed. If the analog input is smaller, the DAC acts as a down counter to subtract one from its setting. This completes the action of the DAC, as denoted by the READY pulse.

The READY pulse triggers a flag in the computer to initiate transfer of the 14-bit address (including multiplexer). After transfer, the computer supplies a RESET pulse which resets the DAC, SC, and the ADC BUSY binary. It is assumed that the computer interrupt is initiated at the start of analysis so that interrupt housekeeping is simultaneous with analysis.

The output of the DAC is negative (using DEC modules for the D-A converters). To improve integral linearity at the expense of differential linearity, the comparator is connected between ground and a resistor bridge which couples together the negative output of the DAC and the positive analog input. By requiring a null in the sum of the two voltages, the comparator forces them to be equal.

Philosophy of Design: The advantage in using a up-down counter for the successive approximation DAC lies in the ability to correct mistakes made early in the approximation. If the analog input voltage nearly equals some multiple of the voltage corresponding to one of the most significant bits (e.g., if it corresponds to a setting between 1777 and 2001 octal), there may be some ambiguity as to whether the analog input is greater or less than the DAC output voltage. In a standard successive approximation techniques, the most significant bits must be set carefully and slowly to allow the voltages to settle. When there is provision for searching at the end, the successive approximations are made more quickly with more tolerance for error. The duration of the .4  $\mu$ sec delays can be adjusted for minimum average total dead time, balancing the time for the successive approximations against the time for correcting errors.

The addition of the 13th bit insures that the final decision on the setting of the DAC is made reproducibly, regardless of the value of the analog input. The 1  $\mu$ sec delays provide adequate settling time for the DAC voltages; and the resetting of the 13th bit insures that the last voltage change before the decision involves only one bit.

Figure 3 illustrates the reaction of the converter to analog input voltages which might result in ambiguous decisions. The dotted lines represent the analog input, and the solid lines are the varying DAC output voltages (in magnitude but not polarity) during the last stages. Figures (a) through (e) represent an analog input exactly halfway between two adjacent DAC output voltages. In (a) and (b) the output is assumed larger than the input originally, and vice-versa in (c) through (e). In both cases there is an ambiguity during the searching, but once this ceases and the 13th bit is reset, the decision whether or not to count down one more bit is clear.

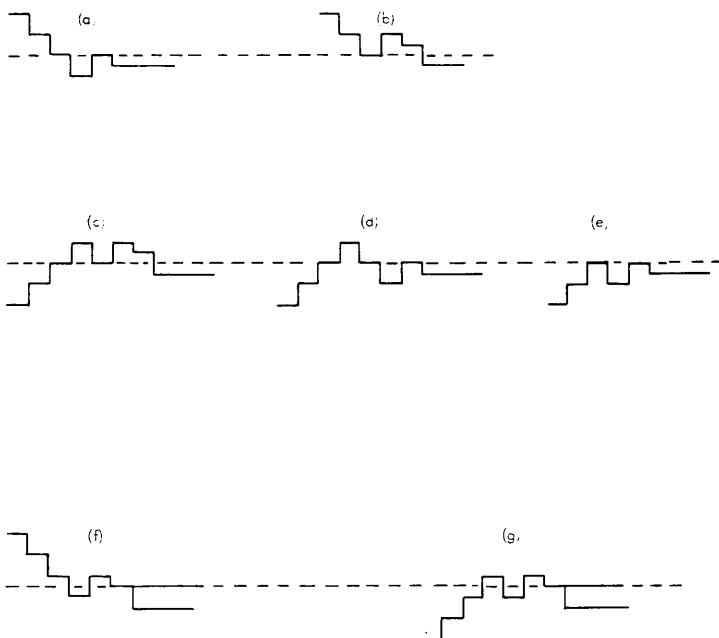

Figure 3

Figures (f) and (g) represent an analog input exactly equal to one of the DAC output voltages. In this case, there is no ambiguity during the searching. Once the search ceases and the 13th bit is reset, a careful decision must be made whether the analog input is to be considered above that setting of the DAC or below it. This decision cannot be avoided, and must be made as thoughtfully and reproducibly as possible.

In this case, the searching procedure always ends with the same three cycles: the DAC output too large, then too small, then too large again. This is followed by a reduction of about .01% in the DAC output by changing only the 13th bit.

During the final delay of 1  $\mu$ sec the output voltage gradually settles to its asymptotic value. The interaction of the comparator and this reproducibly changing voltage is analogous to the periodic sampling of the continually changing ramp voltage in a conventional multichannel analyzer. It is this feature which provides excellent differential linearity and constant channel width. If necessary, the duration of the last delay can be shortened to better simulate this situation.

### Conclusion

The design of a multichannel pulse-height analyzer for nuclear data can be based almost entirely on construction from readily available computer logic modules. This simplifies the fabrication and reduces the development time considerably. Only the linear delay and pulse stretcher for the analog input are nonstandard, and these are commercially available in modular form.

By combining the principles of successive approximation and reproducible discrimination it seems possible to retain much of the excellent differential linearity inherent in conventional pulse-height analyzers with the speed and integral linearity of computer digital-to-analog converters.

I am grateful to Mr. Albert S. Anderson for many helpful discussions concerning this design. (This research is supported in part by the National Science Foundation.)

DECUSCOPE is published monthly for Digital Equipment Computer Users Society (DECUS).

Material for publication should be sent to: Angela J. Cossette, DECUS, Maynard, Massachusetts 01754. Telephone: AC 617 897-8821, TWX 710 347-0212

Publications Chairman: Joseph Lundy, Inforonics, Inc.

Circulation: 1,735 copies per month

DECUS acknowledges the assistance of Digital's Technical Publication Department in the preparation of this newsletter.



# REPORT ON THE JUG/DECUS EXECUTIVE BOARD WORKSHOP

The following is a report presented to the Jug Executive Board on April 25, 1966.

On April 22-23, the JUG/DECUS Executive Board Workshop was held at the John Hancock Mutual Life Insurance Building in Boston, Massachusetts. The purpose of this workshop was to establish a more common foundation between the various member groups of JUG. This report will serve as a brief description of the workshop for the JUG Executive Board. A more complete documentation of the minutes of the meeting is in preparation and will be distributed to the JUG Executive Board and all attendees of the workshop within a month. The workshop was attended by representatives of twelve user groups of JUG: COMMON, CAP, Honeywell 800, SDS, UNIVAC, Raytheon, GUIDE, TUG, G. E., SHARE, G-15 EXCHANGE, and DECUS. The first day's workshop was devoted to the first three items of the agenda: the executive structure of user group, user group meetings, and the user groups' program library. The general plan of all sessions was to move discussion around to each user group in turn, who would describe how each particular item was handled within his group and with what success. After each discussion, other members of the group could ask questions. The workshop was supplemented by a questionnaire that was distributed prior to the meeting in which the statistics of the groups were compiled. In the final report of the workshop committee, the tabulated results of the committee will be included. In addition to completing the questionnaire, each user group was asked to pre-submit the following items:

- Bylaws
- Proceedings
- Newsletter
- Standard Program Writeup
- Program Library Catalog
- Brochure describing the users group
- Library and Certification Procedures
- Sample of any other material regularly published

These items were all collated and bound before the meeting and made available at each user's station during the meeting. Discussion was able to reference individual items of each user group package.

Since this report is only a preliminary document and there was not time to prepare a comprehensive description of the workshop, only highlights will be given in order to give the JUG Executive Board a quick insight into the meeting. Each item of the agenda will be taken in turn.

The statistics of the executive boards of the user groups were largely represented in the questionnaires. Each user group was asked to list all the officers of their executive board and their term of office. Discussion was held as to how user group organizations are financed. There seemed to be a rather large spectrum of the financing of user groups, all the way from complete manufacturer support to rather complete autonomy. In the latter case, it was found that larger user groups could derive essentially autonomous support through registration fees collected at user group meetings. If a user

group meeting attracted, say, 500 or more attendees, apparently a \$10.00 registration fee would be sufficient to run user group business with the exception of the program library distribution. Small user groups, on the other hand, tend to depend almost entirely on the manufacturer for their financial support. Some groups, however, depend on the generosity of a particular group installation to provide such services as newsletter preparation, etc. There was also a lively discussion as to the pros and cons of user group incorporation. A couple of the groups are currently looking into the advantages of incorporation.

The user group meetings showed very wide variations of activities among the various user groups. These figures ranged from under 100 to about 1,200 attendees per meeting. Most user group meetings would run for two days. Some are held in conjunction with the Joint Computer Conferences, especially smaller user group meetings. The content of user group meetings varies widely as well; all the way from formal meetings where formal papers are given and printed in proceedings to meetings in which workshops were held where most of the business is carried on in small round table discussions on specialized subjects. A constructive suggestion was made that several of the smaller user groups could band together and hold joint meetings. This would tend to allow for free meeting rooms and other advantages that accrue from being able to make arrangements for larger groups.

In the area of program libraries, every user group but one has the duplication and distribution of programs and program writeups carried on exclusively by the manufacturer. The various review and certification procedures appear in the materials that were sent to the workshop and some collation of these procedures will no doubt appear. A proposal was made by SHARE for a combined JUG User Group catalog. Discussion of this will appear below.

The second day of the workshop consisted of discussion on user group publications and discussions of future user group directions. In the publications area, the various publications standards were reviewed. Most user groups have regular publication dates of their newsletters. These newsletters are usually about 6 to 10 pages long and consist of application notes; new hardware and software options, program library additions and corrections, programming techniques, meeting announcements, and new membership lists. A comment was made by one of the user groups that when a new and more attractive layout was presented in the newsletter, the circulation suddenly doubled.

A general session was held on the future of the user group; in particular, the future effectiveness of JUG. There has long been the question as to the exact role that JUG should play in relation to the ACM, standards associations, etc. It was generally agreed that the contributions of our user group association must lie in the grass roots since we are the only organization that represent programming at this level. The effectiveness of JUG seems to rest in collective actions within all user groups. The user group combined program library catalog project would be an example of this concept, as would the Computer Applications Digest. Discussion was also held concerning JUG's role with the ACM. It was pointed out that we may well have our own standards committee, etc.,

since we represent the actual programming community. It was also suggested the JUG may want to evolve into a more professional society.

A lively discussion was also held during this session concerning the future of the user group as a software brokerage house. It was pointed out that the rising software costs might lead to a change in the current manufacturer supported software practices. For example, a group of users within a user group might get together and decide they need a particular compiler or other piece of software that the manufacturer for some reason will not provide. Should the user group in some way act as a brokerage organization in either a formal or informal way to set up a contact or even be involved in a contract between the users and a software house? Some definite opinions were expressed on the question and it was generally agreed that the user group should work with the manufacturer, even at the hardware design stage, to insure appropriate software development. While a few user groups, notable SHARE, have had success in this user-manufacturer partnership, most of the other groups have had no experience at all in this area.

It was proposed by SHARE and approved by the attendees of the workshop to propose to the JUG Executive Board to set up Ad Hoc Committee on Intergroup Program Library Interchange for the purpose of the investigation of the effectiveness and usefulness of the individual group program libraries among other members of JUG. In particular, the committee would examine all the procedures for program writeups to see if some standard means of intergroup program communication could be established. The committee would also look into the possibility of establishing a JUG combined program catalog for all the user groups' programs. The committee's specific task would be to reach a decision whether or not it would be worthwhile to establish intergroup communications of programs, and if the answer were affirmative, then a permanent committee would be established to carry this work further, probably to establish the actual user group combined catalog. SHARE agreed to provide the programs and the machine time for the creation of the first user group catalog should the decision to go ahead on this venture be made. The following people volunteered to serve on the Ad Hoc Committee: Chairman-Angela Cossette, DECUS; Richard McQuillin, DECUS; Ben Faden, SHARE; Hal Tuens, SDS; Ray Ellis, COMMON; Elinor Burns, CAP; Bruce Wallis, UNIVAC; and Linda Ferguson, TUG. The report on this committee will be given to either the JUG Executive Board or to the next session of the Executive Board Workshop as discussed below.

As a final note of business, the members of the workshop decided to have another one-day workshop on November 7, 1966 in San Francisco, the day preceding the Fall Joint Computer Conference. The attendees request the Executive Board of JUG to make arrangements for the workshop to be held at that time. One of the items of business would be a report by the Ad Hoc Committee on Intergroup Program Library Interchange.

Note:

Due to present responsibilities, Angela Cossette has asked to be released as Chairman. Mr. Richard McQuillin, Inforonics, Inc., Maynard, Massachusetts has assumed the duties of Chairman.

# DECUS NOTES

## FALL MEETING SET

The DECUS fall 1966 meeting has been set for November 4-5 at Lawrence Radiation Laboratory, Berkeley, California. Plans are underway for one of the most interesting and informative sessions yet. The range of presentations will be from twenty to forty minutes, and the committee hopes to include also a session for short talks and program demonstrations.

Due to the success of the PDP-6 Discussion Session at the Spring Symposium, another session is planned for this meeting. Sessions on other PDPs are encouraged.

A call for papers is included as an insert to this issue.

## DECUS NOTEBOOKS UPDATED

Material updating the DECUS notebook was sent recently to all DECUS Delegates and holders of these notebooks. It included the following:

1. Addendum No. 1 to the Abstracts of DECUS Programs including a revised category index, a new numerical index by PDP, and abstracts of additions to the DECUS Library.
2. Revised Table of Contents
3. 1966 DECUS Executive Board (to be inserted in the DECUS Brochure)
4. Updated List of Installation Delegates
5. Addition to the 1965 Index of DECUSCOPES
6. Index of 1966 DECUSCOPES
7. Addition to the Proceedings Index

Your notebook should contain all the information listed on the revised Table of Contents. If you have an incomplete notebook, please advise the DECUS office.

## LIBRARY MATERIAL REQUEST FORMS ISSUED

New DECUS Library material request forms were recently sent to all DECUS members. We believe they will aid us in expediting library requests and, to a certain extent, eliminate duplication of effort at various installations. A blank form will be returned with each completed library request.

The forms of four sheets each are printed on NCR (no carbon required) paper. The pink copy should be retained by the originator and the remaining three copies sent to the DECUS office. The green (acknowledgement) copy will be returned with you completed request.

An installation delegate's signature is required for a person requesting programs used at a DECUS installation. In this way, we hope the delegate ascertains what programs have been requested, thus avoiding duplication wherever possible.

Individual members, not employed at an installation are exempt from requesting programs through a delegate. Perhaps this procedure will lighten our reproduction burden and assist us in completing library requests within a short period of time. The volume of requests for DECUS programs has been very large during the past few months; we have been sending out an average of 125 programs per month. It has been necessary to delay filling requests for several weeks due to the lack of personnel and machine time. This situation has been alleviated, and we feel that the outlook for the DECUS program reproduction is good. Many thanks for your patience and forbearance with us through this period.

#### PROGRAMS AVAILABLE FROM AUTHORS

Many members have spoken of having programs which they would like to share with other users, but which they have not submitted to the DECUS Library because of lacking documentation or debugging. Members feel, however, that the programs are useful to a certain extent and DECUS would like to make them known and available. To accomplish this, we need your assistance. If you have programs which you feel might be useful to others, but time limits documentation for submission into the DECUS Library, let us know and we will publish a description of the program in DECUSCOPE under the heading, "Available from Authors." We will include this section as part of the standard Program Library catalog. These programs should include a short summary of their purpose, length, I/O equipment needed, etc., and material available for tapes and documentation. Persons interested in using these programs will then request them directly from the authors. Hopefully in this way many programs unknown in the field would become available to more users.

Descriptions of these programs should be sent to DECUS, Maynard, Massachusetts, Attn: Angela Cossette.

#### SPRING SYMPOSIUM FINANCIAL REPORT

The DECUS Spring Symposium which was held at the Hotel Somerset, Boston, in May was the first meeting at which DECUS was sole host. All arrangements with the Hotel went smoothly and the accommodations were adequate and pleasant. The only drawback of holding the meeting without a co-host was that the registration fee ran rather high in order to cover expenses.

All expenses were covered by the registration fee, except the printing and mailing costs involved with the meeting. These are consumed by Digital in the daily expenditures of the operation of DECUS.

Total Income from Registration:	\$1,850.00
Total Expenses:*	\$1,737.75
Balance	\$ 112.25

This balance was deposited in the DECUS treasury to aid in deferring future meeting expenses.

\*An itemized list of expenditures is in the DECUS files and may be reviewed by any member upon request.

#### A FEW STATISTICS!

The DECUS Office has been extremely busy these past few months, and we felt that the membership would be interested in knowing how the user group has grown both in number of members and the demand on its services. Below are the statistics presented to the Executive Board for the period January through June 1966.

Applications for Membership Submitted:	259
Membership to Date:	594
Number of Individuals on our DECUS- COPE Mailing List:	830
DECUSCOPE CIRCULATION:	1,735
Circulation at the end of 1965:	1,400
DECUS Library Programs Sent Out:	808
Programs Submitted to the Library:	21
Programs Presently in the Library:	167

#### Miscellaneous Mailings

DECUS Spring Meeting Invitations and registration forms to membership.

JUG/DECUS Workshop information and registration forms to 125 individuals.

Approximately 200 DECUS three-ring binders issued.  
Library catalogs issued to all new individual members.

Addendum No. 1 to the Library catalog to the membership.

Revisions to the DECUS binders to all delegates.

Nomination ballots to all members.

Library Request Forms to the membership.

Minutes of Executive Board Meetings to all delegates.

Fall 1965 Proceedings to all delegates.

DECUS Software Questionnaires to the membership.

The above material is in excess of our regular monthly mailings of DECUSCOPE and our daily correspondence which averages out to approximately 100 letters per month.

The DECUS staff (3) perform all the tasks of mailings and all the duplication and distribution of library programs. Printing of all literature and the typing of DECUSCOPE are the only tasks which are not physically handled by the DECUS staff.

# LETTERS TO THE EDITOR

340 DISPLAY PROGRAMMING MANUAL

DEVELOPED BY DECUS MEMBER

Dear Sir:

"The Systems Science Laboratory of the Department of Industrial Engineering and Operations Research at New York University is built around a PDP-7 Computer and its associated 340 Displays. One of the major obstacles to effective use of the 340 Displays has been a conspicuous lack of programming information. To fully understand the operation of the Display, the programmer must master no less than six technical manuals primarily written for service personnel. These manuals, as a group, are incomplete, contain contradictory information (errors), and are not easily obtainable.

The information contained in this Preliminary Programming Manual comes from the technical manuals (with corrections) mentioned before, from technical prints, from telephone conversations with Mike Ford at Digital Equipment Corporation, and from over a year of programming and experimentation.

Some of the charts and summary information were compiled at an earlier date, but the task for assembling the entire manual was put off until the present time. It is my sincere hope that this manual will be of use to future 340 Display programmers."

"P.S. Most of this work was done on my own time since the department was not in a position to finance the effort."

Editor's Note

The manual is in production and should be available as DECUS No. 7-13 within the next few weeks.

Sanford Adler  
Bronx, New York

Dear Sir:

"I was very happy to see my programs accepted as DECUS 7-10 through 7-12. I would like to point out a few errors in Decpun and Pospnt (7-10 & 7-11) which should be corrected:

1. The routines will not work correctly if the Link is set when entered. Therefore, a revised tape is enclosed which includes a CLL with the first instruction.
2. The LAC (LAM-x) instruction in the routine modification setup is correct but not optimum, LAM-x alone is better.
3. Due to a typographical error, the minus sign in the phrase "Y is 6 - (number of digits desired)", was omitted.

I hope you will bring these corrections to the attention of DECUS members."

Luther C. Abel  
Rennselaer Polytechnic Institute  
Troy, New York

# NEWS ITEM

AACHEN JET ENGINE RESEARCH  
WILL UTILIZE PDP-7 COMPUTER

The German Research Institute for Jet Propulsion and Turbine Engines in Aachen directed by Prof. W. Dettmering plans to use a PDP-7 computer in gathering experiment data at a test stand for compressors. The goal of the project in which the computer will be used, is to describe precisely the gas flow mechanisms in compressors in the sub- and supersonic speed ranges.

The Institute staff have developed instrumentation to measure precisely such parameters as flow direction and speed in three dimensions, in various parts of the compressor. The staff also developed interface logic circuitry to connect this and other planned instrumentation to the computer, utilizing FLIP CHIP modules, a multiplexer, analog-to-digital converters, x and y plotters, and a dual DECtape transport and control.

Because of its high operating speed, the computer will be able to collect the measurement data, as well as control the experiment, check the instruments, correct the data, evaluate it on the basis of prestored information, and display it on the plotters. In addition to the compressor test stand, it will later collect and analyze data on other test beds evaluating further aspects of air-cooled engine operations.

## NEW DECUS MEMBERS

### PDP-1 DELEGATE

Jaq Russell  
Data Systems Division  
Standard Telephone & Cables Ltd.  
England

### PDP-5 DELEGATES

E. D. Earle  
Atome Energy of Canada Ltd.  
Chalk River, Ontario

Austin Hoggatt  
University of California  
Center for Research of Management Science  
Berkeley, California

### PDP-6 DELEGATE

Robert Henry  
University of California  
229 MB-Virus Laboratory  
Berkeley, California

# NEW DECUS MEMBERS

## PDP-7 DELEGATES

Prof. Dr.-Ing. Wilhelm Dettmering  
Dept. of Turbo Engines  
Aachen Technical School  
Aachen, Germany

P. L. Latour  
Instituut Vodr Zintuigfysiologie-  
R.VO-T.N.O.  
Soesterberg, The Netherlands

Dr. Rolf Nordhagen  
University of Oslo  
Nuclear Physics Laboratory  
Oslo, Norway

Roger C. Pyle  
Stromberg-Carlson Corporation  
San Diego, California

Thomas Weyand  
Technical Advisors, Inc.  
Wayne, Michigan

M. J. L. Yates  
A.W.R.E, Nuclear Research Div.  
Aldermaston, Berkshire  
England

## PDP-8 DELEGATES

J. Harvey  
Communication Systems Inc.  
Paramus, New Jersey

F. Lewin  
University of New South Wales  
School of Electrical Engineering  
Kensington, Australia

Jacob L. Meiry  
Massachusetts Institute of Technology  
Aero & Astro,  
Man-Vehicle Control Lab.  
Cambridge, Massachusetts

H. E. Schnader  
Mobil Oil Company  
Torrance, California

B. L. Shaw  
Hydrological Research Unit  
Natural Environment Research Council  
Howbery Park, Wallingford  
Berkshire, England

## INDIVIDUAL MEMBERS

Barry John Allen  
Australian Atomic Energy Commission  
Sydney, N.S.W. Australia

Patrick Francis Bampton  
U.K.A.E.A. Aldermaston  
Kingsclere, Newbury  
Berkshire, England

J. W. Birtill  
A.W.R.E. Aldermaston  
Berkshire, England

Joseph D. Bosia  
Mitre Corporation  
Bedford, Massachusetts

James W. Bowman  
Atomic Energy of Canada, Ltd.  
Chalk River, Ontario

William H. Boyd  
Uniroyal-U.S. Rubber  
Detroit, Michigan

Jeff Buckwalter  
Learning Research & Development Center  
University of Pittsburgh  
Pittsburgh, Pennsylvania

Craig M. Cook  
University of Pittsburgh  
Pittsburgh, Pennsylvania

Joseph Doron  
The Data Master Corporation  
Glen Cove, New York

Eleanor S. Erickson  
Sylvania Electronic Systems  
Needham, Massachusetts

George P. Ford  
Los Alamos Scientific Laboratory  
Los Alamos, New Mexico

Donald A. Glaser  
229 MB-Virus Laboratory  
University of California  
Berkeley, California

## INDIVIDUAL MEMBERS (Continued)

Dale J. Gordon  
Army Map Service  
Washington, D.C.

James Gottschalck  
Sylvania Electronic Systems  
Needham, Massachusetts

Tore Hvam  
University of Oslo  
Institute of Physics  
Oslo, Norway

Finn Ingebretsen  
Fysisk Institutt  
University of Oslo  
Oslo, Norway

Mary Leo  
Learning Research and  
Development Center  
University of Pittsburgh  
Pittsburgh, Pennsylvania

Malcolm F. Moore  
Data Systems Division  
Standard Telephone & Cables Ltd.  
Hertfordshire, England

Colin Nettleton  
National Gas Turbine Establishment  
Pyestock, Hants, England

Harold F. Nieman  
Atomic Energy of Canada Ltd.  
Chalk River, Ontario

Janet M. Stropki  
Numerical Control & Computer Services  
Cleveland, Ohio

H. R. Tempest  
Nuclear Physics Laboratory  
Oxford, England

Selene H.C. Weise  
Mount Wyndham, Bailey's Bay  
Bermuda

Robert M. Zeigler  
Bell Telephone Laboratories, Inc.  
Holmdel, New Jersey

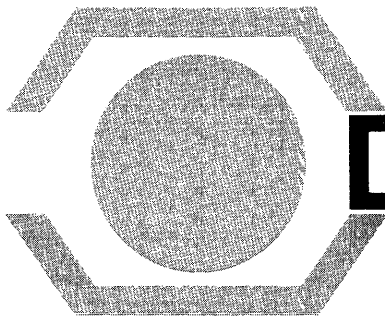

# DECUSCOPE

DIGITAL EQUIPMENT COMPUTER USERS SOCIETY

1966  
Vol. 5 No. 6

## DECUS EUROPEAN SEMINAR

The DECUS European Seminar was held on April 27-28, 1966 at the Washington Hotel London, England. Fifty-two members representing six countries and twenty-one installations, were in attendance. Fifteen papers were presented, the abstracts of which are included as an insert to this issue. Proceedings of this seminar should be available soon.

It was generally felt that the meeting had proven to be well worthwhile and that much could be gained from further meetings. Members realized the great value of making contacts with other members, thereby gaining new ideas.

A regional committee was established, and a chairman, vice-chairman, and five other members were elected. The officers and members elected are as follows:

Chairman:	Dr. B. E. F. Macefield Nuclear Physics Laboratory Oxford, England
Vice-Chairman:	H. Karl III Physikalishches Institut, T. H. Aachen, West Germany
Committee Members:	L. P. Goodstein Research Establishment Riso Roskilde, Denmark
	J. Miller D. Laurent Laboratoire Chimie Organique Physique Paris, France
	M. A. A. Sonnemans Institute for Nuclear Physics Research Amsterdam, Netherlands
	M. C. Turnill Department of Physics Imperial College London, England
	Dr. P. J. Twin Chadwick Laboratory University of Liverpool Liverpool, England

The next meeting has been scheduled for late October in Aachen, West Germany.

## DECUS AS A NONPROFIT CORPORATION

The DECUS Board has recently been considering the advantages of transforming DECUS into a nonprofit corporation. If this is done there will be no change in the obligations of membership, and three advantages will be gained:

1. Liability of officers will be limited.
2. The membership will be assured of receiving regular reports about DECUS finances, since these reports must be prepared for the government.
3. Corporate status will provide visible separation from DEC.

The first of these advantages can be gained only by incorporation, and the second without incorporating. The third is a largely psychological advantage since DECUS, at present, is completely dependent on DEC for financial support of its services to members. In this respect, however, DECUS has negotiated a written agreement describing the type of services to be supplied by DEC; this agreement is subject to annual review by both parties. To the extent that DECUS can find sources of support independent of DEC, DECUS can undertake projects not covered by the agreement. In such cases, the corporate structure will provide a reminder that DECUS and DEC are indeed separate organizations. If DECUS incorporates, the present membership will automatically become members of the corporation. There will also be some small changes in the bylaws.

On the whole, the Board feels that incorporation will probably be advantageous to DECUS. Many DECUS members are, no doubt, already members of other corporations such as the Association for Computing Machinery, so there need not be any uneasiness at the prospect of belonging to a corporation rather than a "society."

The Board will welcome comments from members on this question, and unless serious objections are raised, DECUS will probably become a nonprofit corporation in a few months.

John Goodenough  
DECUS President

# PROGRAMMING NOTES

## REVISED PDP-8 HI-SPEED RIM LOADER

D. A. Campbell & B. L. Stumpf

The Foxboro Company  
Foxboro, Mass.

Problems have arisen regarding the standard DEC RIM loader for the high-speed reader since it is two instructions longer than the low-speed version, meaning:

1. Different starting addresses .
2. Clobbering the JUMP START to the binary loader in 7777 when reading in tapes.
3. All instructions are off-set so the complete loader must be reloaded when replacing one version with the other.

The revised version of the high-speed RIM loader which fol-

lows is two instructions shorter, allowing it a one-for-one correspondence with the low-speed version. Only five instructions may be altered when changing from one version to another. An easier to remember starting address of 7774 may be used.

A loader in any 4K core bank may be used to load tapes into all banks. One instruction (location 7765) differs from the current version of the low-speed loader to make it compatible with the necessity in the high-speed version for clearing the AC when leader/trailer code is encountered.

### PDP-8 Compatible High-and Low-speed RIM Loaders

#### OPERATION:

1. Toggle desired Loader into locations shown below.
2. Set instruction field equal to bank where Loader located data field equal to bank in which to load the RIM tape.
3. Put starting address 7774 into switch register.
4. Press LOAD ADDRESS and START.

<u>Absolute Address</u>	<u>Low-Speed Contents</u>	<u>High-Speed Contents</u>	<u>Tag</u> <u>Tag</u>	<u>Symbolic Low-Speed</u>	<u>Symbolic High-Speed</u>	<u>Comment</u>
7756,	6032	6014	* GET,	KCC	RFC	
7757,	6031	6011	*	KSF	RSF	/SKIP ON FLAG
7760,	5357	5357		JMP .-1	JMP .-1	
7761,	6036	6016	*	KRB	RRB RFC	/READ BUFFER
7762,	7106	7106		CLL RTL	CLL RTL	/(& RESELECT)
7763,	7006	7006		RTL	RTL	/CH. 8 IN AC 0
7764,	7510	7510		SPA	SPA	/CHECK LEADER
7765,	5374	5374		JMP BEG	JMP BEG	/CLEAR AC
7766,	7006	7006		RTL	RTL	/OK, CH. 7
7767,	6031	6011	*	KSF	RSF	/IN LINK
7770,	5367	5367		JMP .-1	JMP .-1	
7771,	6034	6012	*	KRS	RRB	/READ, DON'T CLEAR
7772,	7420	7420		SNL	SNL	
7773,	3776	3776		DCA I TEMP	DCA I TEMP	/STORE CONTENTS
7774,	3376	3376	BEG	DCA TEMP	DCA TEMP	/STORE ADDR (&
7775,	5356	5356		JMP GET	JMP GET	/CLEAR AC)
7776,	-	-	TEMP	-	-	
7777,	JMP START OF BINARY LOADER					

\* The five instructions with an asterisk are the only ones which differ between the high-and low-speed versions.

# DUPLICATING BINARY LOADER

Thomas D. Rarich  
M. I. T.  
Cambridge, Mass.

Many PDP-8 users have an ASR-33 Teletype as the only means of reading and punching binary tapes. In such cases, for reasons of speed and efficiency of operation, it is often desirable to duplicate a binary tape while it is being read into the computer using the Binary Loader.

The following changes in the Binary Loader gives the user a new bit 0 option. The conventional Binary Loader reads from the ASR-33 if bit 0 of the switch register is up, or from the 750C if bit 0 is down. The Duplicating Binary Loader reads from the ASR-33 if bit 0 is up, and reads and punches from the ASR-33 if bit 0 is down when the program is started. In all other respects the Duplicating Binary Loader operates exactly the same as the conventional Binary Loader. The new Binary Loader duplicates all leading code 200 tape which is read but ignored by the program. Since the program stops as soon as it encounters trailing code 200, the user must generate his own trailer off-line following the checksum.

The Duplicating Binary Loader occupies the same locations in memory as the conventional Binary Loader. The program has no check facility, but if the program is read in correctly and the teletype punch is operating properly, a correct duplication results for the user.

## Punch Option:

If bit 0=0, the program punches duplicate tape while loading the original into memory. Program will no longer read from the High-Speed Reader.

Program Changes to convert Binary Loader to Duplicating Binary Loader:

Location	Instruction	Octal Equivalent
7661	7671	7671
7663	TLS	6046
7664	TSF	6041
7665	JMP .-1	5264
7703	DCA 7674	3274
7751	JMP 7663	5263
7752	0003	0003

DECUSCOPE is published monthly for Digital Equipment Computer Users Society (DECUS).

Material for publication should be sent to: Angela J. Cossette, DECUS, Maynard, Massachusetts 01754. Telephone: AC 617 897-8821, TWX 710 347-0212

Publications Chairman: Joseph Lundy, Inforonics, Inc.

Circulation: 1,735 copies per month

DECUS acknowledges the assistance of Digital's Technical Publication Department in the preparation of this newsletter.

# DECUS PROGRAM LIBRARY

PDP-1 PROGRAM LIBRARY ADDITIONS

## DECUS No. 76

The 28-bit Floating Point Package for the PDP-1 has been revised. An error was found in the multiply routine and corrected tapes are now available.

## DECUS No. 88

Title: Typewriter Time Test for the PDP-1

Author: Lloyd J. Ostiguy, Inforonics, Inc.  
Maynard, Massachusetts

This program indicates length of time elapsed between consecutive key strokes and calculates the mean, variance and standard deviation (msec/character). Storage requirements: 5125<sub>8</sub>.

PDP-5/8 PROGRAM LIBRARY ADDITIONS

## DECUS No. 5/8-38

Title: FTYPE - Fractional Type

Author: Paul T. Brady, New York University,  
Bronx, New York

Fractional Type enables a user to type fractions of the form .582, -.73, etc., which are interpreted as sign plus 11 bits (e.g., 0.5 = 2000<sub>8</sub>). Subroutine reads into 3000-3177 and is easily relocated, as it works on any page without modification.

## DECUS No. 5/8-39

Title: DSdprint, DDtype - Double Precision Signed Decimal Input/Output Subroutine

Author: Paul T. Brady, New York University,  
Bronx, New York

DSdprint, when given a signed 24-bit integer, types a space or minus sign followed by a 7-digit decimal number in the range - 8388608 to + 8388607.

DDtype enables the user to type in a signed decimal number in either single- or double-precision. These routines are already separately available, but the present subroutine package occupies only one memory page and allows for more efficient memory allocation. Subroutine is located in 3000-3177, but works on any page.

## DECUS No. 5-40

Title: ICS One Page DECTape Routines

Author: Information Control System, Inc.,  
Ann Arbor, Michigan

The routines read or write from the specified DECTape unit



and delay the program until all I/O is completed. The last block read overflows the specified region and destroys one core location. Only standard 129 word DECtape blocks are read or written. The routines halt if an error occurs with the status bits in the AC.

#### DECUS No. 5-41

Title: Breakpoint

Author: Arthur R. Miller, Woods Hole Oceanographic Institution, Woods Hole, Massachusetts

This debugging routine has been reduced to a minimum operation. It is a mobile routine which can operate around any program that leaves an extra 30 cells of memory space.

Its function is to insert break points in any given location of the program being debugged, and to hold the contents of AC and Link. The programmer may examine any locations desired and then continue to the next breakpoint. It is presently located in  $140_8 - 170_8$ , but may be easily relocated.

#### DECUS No. 5-42

Title: Alphanumeric Input

Author: Paul D. Hammond, Woods Hole Oceanographic Institution, Woods Hole, Massachusetts

With the Alphanumeric Input Package, any character may be read into the PDP-5 through either the Teletype or the High-Speed Reader. The characters are packed two/cell and stored in the address indicated in the switch register.

To prepare a symbolic tape, type it on the Teletype and for the last character use the "&" sign. The "&" is used as a signal to store the 0001 code which the Teletype Output Package seeks as a stop code.

The program reads the SR twice: first, to determine if the symbolic information is to be read in through the High-Speed Reader or from the Teletype, and second, to determine the initial address of the symbolic information.

### PDP-7 PROGRAM LIBRARY ADDITIONS

#### DECUS No. 7-14

Title: ISENSE

Author: Philip R. Bevington, Stanford University, Stanford, California

ISENSE is a FORTRAN function permitting the use of the AC switches on the PDP-4/7 or the SCANS Idiot box spectrum-stripping switches as sense switches. It also uses the Idiot box display scale switch with scope display, or plots programs as a PTSCOPE. This subroutine is written entirely in PDP-4/7 symbolic and utilizes the EAE commands. The storage requirement is  $49_8$ .

#### DECUS No. 7-15

Title: FORTRAN Patch for EAE Arithmetic

Author: Philip R. Bevington, Stanford University, Stanford, California

This subroutine is a modification to the FSWMIO FORTRAN for the PDP-4/7, taking advantage of the EAE arithmetic to increase the speed of computation by a factor of 2.5 for 2-word mode. This patch corresponds to FSWMIO FORTRAN, September 14, 1965. To modify for any other version of FORTRAN, it may be necessary to change the location address listed at the beginning and end of the patch.

#### DECUS No. 7-16

Title: Single Level Breit Wigner Fit

Author: P. Paul, Stanford University, Stanford, California

This FORTRAN program calculates the energy dependence and size of the total cross section of a single isolated resonance in the R-matrix formalism of nuclear theory. Included are subroutines for calculating Coulomb wave functions and phase shifts.

## NEWS ITEMS

### TWO PDP-8s WILL CONTROL ANTENNAS FOR EASTERN PACIFIC COMSAT LINK

Two PDP-8 computers will control the aim of the 85-ft dish antennas beaming the first commercial communications traffic across the eastern Pacific via orbiting satellites. The new link will significantly expand existing telephone and teletype capacity across the Pacific and provide the means for relaying commercial live television broadcasts. Sylvania Electric Products Inc. is building the two ground antenna systems in Washington and Hawaii, under a \$4.6 million prime contract from the Communications Satellite Corporation (COMSAT).

The two ground stations, consisting of receivers, transmitters, voice multiplexers, antennas, computer-based antenna control systems, and bore-sighting towers, are scheduled to be ready for commercial traffic in early 1967. The movable portion of each antenna weighs more than 135 tons, approximately 1000 times the weight of the computer controlling it. Turning rate is one revolution per minute, and pointing accuracy is within  $1/25$  of a degree at a distance of 22,300 miles (the altitude at which satellites orbit in synchronism with the earth). The antennas will be homed on a beacon transmitted by the satellites. Tracking control modes include manual, programmed, and automatic. In the automatic mode, the computer compares predicted satellite positions in an ephemeris table, with data taken from shaft angle encoders on the antenna pedestal making corrections as needed to the stored data. The programmed mode will be used if difficulty is encountered in automatic tracking, and a scan mode is also provided in the event tracking is lost.

# DECUS EUROPEAN SEMINAR

April 27-28, 1966

## ABSTRACTS OF PAPERS

### DATA ANALYSIS SYSTEMS WITH THE PDP-4 IN THE NEUTRON PHYSICS GROUP AT HARWELL

E.M. Bowey, M.R. Avery, D.B. McConnell  
Nuclear Physics Division, AERE, Harwell, England

A PDP-4 with 16K extra memory is used primarily for neutron time-of-flight data analysis. Real time events recorded on 1 in. magnetic tape are converted to spectra, displayed for inspection, and recorded on 1/2 in. magnetic tape. Further uses of the computer are also discussed.

### THE ML/I MACRO PROCESSOR

P. Brown, Mathematical Laboratory, University  
of Cambridge, England

ML/I is a general macro language recently designed and implemented on the PDP-7. The user of ML/I can choose any single character of any identifier for each macro name and for each macro argument delimiter. A tree of options may be specified for the argument delimiters of a macro; there are no restrictions on nesting of macros, and recursion is permitted. There are facilities for integer arithmetic and conditional GO TO at macro-time. ML/I has been designed so that, in addition to its obvious use for extending assembly language, it can be used for a wide variety of text manipulation and conversion operations. Examples are error correction and simple language translation such as fully parenthesized algebraic notation to Polish prefix. An important use of ML/I might be in extending existing languages to provide languages oriented to particular groups of users.

### ON-LINE STEEL SAMPLE ANALYSES WITH PDP-5

H. Broekhuis, Royal Netherlands Steelworks,  
Ijmuiden, Holland

In one of our laboratories the chemical composition of steel samples received from several plants is determined by means of two spectrometers. Light emitted

by an electric arc between the sample and an electrode is separated in its components, each of which charges a capacitor to a voltage related to the concentration of an element by means of a photocell. These voltages are scanned and digitized by the computer. After the scanning is complete the chemical composition of the sample is calculated; the result is compared with certain determined limits. The results are then printed on a number of teleprinters and punched on cards.

The laboratory, working on a three-shift basis, handles about 1000 samples a day; the time required per sample is approximately 3 minutes. Operation of this system started in March, 1965, and has been working day and night since then without a single failure.

### THE MANCHESTER VAN-DE-GRAAF ON-LINE COMPUTER FACILITY

R.L.A. Cottrell, The Physical Laboratories,  
The University, Manchester, England

The PDP-7 at Manchester is being used with some additional hardware to accept on-line data from nuclear particle and gamma ray detectors and to store, display and process this data. The general features provided in the system and the programs are described.

### USE OF PDP-8 COMPUTERS AT DENMARK'S AEC RESEARCH ESTABLISHMENT RISØ

L.P. Goodstein, Electronics Dept., AEC,  
Røskilde, Denmark

During 1966, the electronics department at AEC-Risø expects to have PDP-8 computers operative in two different, but related applications: the first makes use of a PDP-8 in a process monitoring configuration; the second PDP-8 will form part of a small hybrid facility to which the department's existing analog computer will be connected.

The process to be monitored is a nuclear irradiation experiment. Initially, the computer system will

operate in parallel with the existing analog instrumentation. The computer will be used as follows:

1. To control associated peripheral equipment such as scanners, analog-to-digital converters, etc., to collect and store the outputs of the process transducers.
2. To process the data to establish current status for each parameter.
3. To output various data formats including both operational and bookkeeping requirements.

Risø personnel are developing most of the special interfaces required and are also doing all of the programming. Since the system is experimental, memory size limitations are not expected to become a serious problem. Two related factors which are of considerable interest are the reliability of such a system and the opportunities which exist for improved closed loop control and man-process communications. Efforts planned in these areas are described.

To assist in various studies being carried on, the second PDP-8 will be used in conjunction with a Risø-built analog computer to form a small hybrid facility, with special interface designed to couple the two machines. Immediate areas of activity, apart from evaluation of the hybrid system itself, range from the simulation, design and optimization of digital control systems to the simulation of albumin exchange in the human body.

#### GENERAL PURPOSE NETWORK DESCRIPTION PROGRAM FOR COMPUTER WITH VISUAL DISPLAY

H.P. Hutchison, Department of Chemical Engineering, University of Cambridge, England

The program is intended for general use as a subroutine to FORTRAN II programs. Such programs may have a variety of purposes, in any field in which the essence of a problem can be set up as a network of nodes and links. A program for any specific purpose will be the user's responsibility and is called a user's program. The network description program (NETDES) is entered from the user's program and itself calls the display manipulation program (DISMAN). Together, they permit the building up of a display on the screen of labelled nodes and links and the construction of a corresponding descriptive table accessible to the user's program. They also permit the assignment of parameters to individual nodes or links, which may be used by the user's program as constants or variables in the calculation. Control can be returned to the user's

program whenever required, and reentry to NETDES is then under program control—a provisional version is operating satisfactorily.

#### PROBLEMS OF TIME-SHARING A PDP-7

B. Macefield, Department of Nuclear Physics, University of Oxford, England

The on-line data handling and computing requirements of the Oxford electronic generator group will be examined. The difficulties encountered in the practical implementation of these demands will be discussed in the context of the PDP-7 presently installed.

#### CORAL ON-LINE TIME-SHARING SYSTEM

G. Murray, Department of Nuclear Physics, University of Oxford, England

A PDP-7 with a 20K memory is the heart of a time-sharing data collection system placed in operation at the Oxford University Nuclear Physics Laboratory. Software and hardware have been developed to provide normal DECSYS FORTRAN use and simultaneous data collection on up to four priority channels.

This paper describes CORAL (Coping with Obtuse Researchers with Analytical Leniency), a program and associated hardware which supervises the time-sharing system and controls the on-line multi-channel pulse height analysis.

#### AEROFOIL DESIGNER'S AID

K. Paton, Mathematical Laboratory, University of Cambridge, England

In finding the pressure distribution on an arbitrary aerofoil in two-dimensional, inviscid, irrotational, incompressible flow, a common theoretical and practical technique is to map the complement of the aerofoil conformally on the complement of a disc in such a way that the points at infinity correspond and the derivative of the transformation is finite and non-zero at infinity. The velocity distribution on the disc in a uniform stream is easily found and a simple calculation gives the velocity distribution on the aerofoil. Lastly an application of the Bernoulli relation:

$(\text{Pressure})/(\text{density}) + (\text{velocity})^2 = \text{constant}$   
gives the pressure distribution on the aerofoil.

ADA, Aerofoil Designer's Aid is an interactive system for studying the effect of operator-specified linear transformations on the convergence of otherwise automatic iterative mapping techniques which conformally map the complement of an arbitrary aerofoil onto the complement of a disc.

It consists of:

1. a set of mapping subroutines in Atlas 2.
2. a set of linear transformations in PDP-7.
3. a display of the current aerofoil on the PDP-7 screen; and
4. the associated communicative program controlling the link between the two computers.

Conventional mapping techniques apply a given mapping to the  $n$ th iterate to obtain the  $(n+1)$ th. In some cases it is possible to radically improve the convergence of the process:

- a. by using different types of mappings at different stages of the process.
- b. by carrying out intermediate simple linear transformations in order to make the  $n$ th iterate more likely to produce a proper  $(n+1)$ th iterate. Here proper means much more nearly circular in an appropriate sense. The eventual aim is to construct a selection procedure which chooses the mapping which will produce an acceptable improvement. To gain insight into what constitutes improvement and how it can be measured, we rely on an interactive system in which the transforms furnished by Atlas are called in as required by the user who observes their effect by watching the displays of the current aerofoil on the screen. He can also attempt to speed the convergence by carrying out conformal linear transformations in the PDP-7 itself. Thus he may observe the effect of certain strategies such as moving the origin of coordinates into the thickest part of aerofoil; strategies not easy to program and therefore to attempt in other ways.

## CONTROL ENGINEERING PROBLEMS

M. Pleeging, Control Engineering Laboratories,  
Technische Hogeschool, DELFT, Holland

As examples of the types of problems which are explored in the Control Laboratory of the Electrical Department of the Technological University at Delft, the following systems are discussed:

1. Speed control of a dc motor--as a measure of the speed of the elapsed time used between two

pulses from an incremental analog-to-digital converter. This converter produces 1200 pulses per revolution. The elapsed time is measured by counting a standard frequency via the increment on data-break facility of the computer. The speed range is 10-1000 rev/min. The accuracy is 1% of the set value at any desired speed in the speed range.

2. Economic optimization of electric power production--this is discussed as an example of hybrid computation. At this point distinction can be made between static and dynamic optimization. The former is performed by the analog computer and the latter by the digital computer. The state of the different power producing elements is transferred by the A/D and D/A converters. An appreciable gain in time is achieved with respect to a fully digital computation.

3. Plotting of root-loci--as the root-locus method for analyzing linear control systems (continuous as well as sampled data systems) continues to be one of the most powerful methods, a program is prepared which immediately visualizes the root-locus for given pole-zero configurations on the cathode ray tube display. When the pole-zero locations are represented by dc-voltages the influence of changes in the poles and zeroes can easily be studied, and so the synthesis of compensation networks is simplified.

## FORTRAN PROGRAMMING FOR DISPLAY UNIT

M.J. Poole, Nuclear Physics Division,  
AERE, Harwell

An addition to the FORTRAN operating system will be described which allows the Type 30G Display and Type 33 Symbol Generator to be programmed entirely through FORTRAN. Both symbol and graphical output are available and scaled axes are automatically provided on the latter.

## ANALYSIS OF PARTICLE TRACKS IN SPARK CHAMBERS

A. Seidman, Physical Laboratory,  
University of Southampton

An automatic system for scanning, digitizing, and analyzing tracks of particles in spark chambers, using a television camera and PDP-8, was developed and used to measure angles of tracks. The PDP-8 serves as a store for the digitized locations of the

spark, and handles the data before reading out to magnetic tape. The system is briefly described, the interface with the PDP-8 is given and a program dealing with the stored data from the experiment is shown.

#### ALBIN, A PDP-8 LOADER FOR RELOCATABLE BINARY PROGRAMS

J.L. Visschers, P.U. Ten Kate, Institute for Nuclear Physics Research, Amsterdam, Holland

As part of the current design of a PDP-8 real-time monitoring system, a simple method has been found to construct relocatable binary formatted programs, using the PAL III assembler. Allocation of these programs can be varied in units of one memory page (128 decimal registers).

While loading an ALBIN program, the actual absolute addresses of indicated program elements, e.g., the keypoints of subroutines, are noted in fixed program-specified locations on page zero.

To make a DEC symbolic program suitable for translation into its relocatable binary equivalent, minor changes are required, which, however, do not influence the length of the program. Due to its similarity to the standard DEC Binary Loader, the ALBIN Loader is also able to read in normal DEC binary tapes. The Loader is presented here in its simplest form, although the loading method, in a slightly advanced manner, will be used for automatic piling, while loading of arbitrary sequences of more or less independent programs. In the form described, ALBIN requires 120 decimal locations, the RIM Loader included.

Piling up in core memory of ALBIN programs stored on conventional or DEC magnetic tape can be achieved using the same method with some trivial modifications.

#### AN ON-LINE SCOPE TEXT EDITING PROGRAM

N.E. Wiseman, Mathematical Laboratory,  
University of Cambridge, England

This paper describes the development of an experimental text editing program using a PDP-7 Computer and 340 Display. The program is controlled by commands issued via a light pen and a teleprinter keyboard; monitoring of the text is provided by a cathode ray display which serves as a window into the text. A reasonably comprehensive range of edit functions are provided, oriented primarily to program development applications.

#### ON-LINE CONNECTION OF SEVERAL IEP'S TO A PDP-6

University of Aachen, Germany

A method for evaluating bubble chamber pictures by on-line connection of several digitized measuring machines to a PDP-6 will be reported.

The measured coordinates on the film are transmitted via an interface and the 630 Data Communication System unit to the central processor; I/O control goes over the 630 unit, similar to a Teletype, but the input data are put directly on the data bus. The PDP-6 multiprogrammed time-sharing monitor (T.S. EXEC.) is modified, permitting use of the complete possibilities of the time-sharing system. Thus, the ALAF6, a FORTRAN II program controlling the measurements, can be run as user's program. It performs the full geometrical reconstruction of the tracks. Error-messages are typed out on the Teletype belonging to each machine, and results are stored on a microtape.

APPLIED DATA RESEARCH, INC.  
ANNOUNCES PURCHASE OF PDP-7 AND  
338 DISPLAY

Applied Data Research, Inc. has announced the purchase of a PDP-7 and an on-line 338 Display System. The initial configuration includes: 8 tape units, high-speed paper tape, two Teletype consoles, 16,000 words of memory on the PDP-7, 8,000 words of memory on the 338 Display System, a Potter High-Speed Printer, and a special high-speed camera under program control.

Installation of the equipment is scheduled for July, 1966 at ADR's Princeton, New Jersey offices. A special software system is currently being developed under the direction of David J. Waks to facilitate the use of the equipment in the major areas of research. ADR will use this system for continuing basic research in:

1. The formulation of "Mem-Theory"; a technique being developed under Dr. Anatol W. Holt's direction for the analysis of complex information systems independent of their implementation and application of this theory to various existing information systems.
2. The development of data structuring and accessing methods for information retrieval.
3. The development of new techniques for graphic data processing.
4. The development of new techniques for computer program documentation, continuing the line of products started with the AUTOFLOW Computer Documentation System.

Most of the efforts to date in the utilization of Mem-Theoretic techniques have been in the area of data management systems. According to Richard C. Jones, ADR President, the potential application areas of "Mem-Theory" appear to be quite broad. Applied Data Research expects to use "Mem-Theory" and its related computational facility in several new application areas during the next twelve months.

DANISH ATOMIC SCIENTISTS  
USING PDP-8 COMPUTER

The Danish Atomic Energy Commission is using a PDP-8 for experiments being carried on with the DR 3 research reactor. The electronics department of the commission's Research Establishment Risø in Røskilde, in association with the reactor operational and development groups, is currently planning to gather data with the PDP-8 in a fuel irradiation experiment. This experiment, which has been using conventional analog instrumentation, is expected to produce useful experience in computer gathering, analyzing, and displaying of data generated during the operation of the reactor.

It would lead in time to use of the computer for control of the experiment, for monitoring the reactor, and ultimately, after critical safety and reliability requirements are defined and satisfied, for actual computer control of the reactor itself.

## NEW DECUS MEMBERS

### DELEGATES

#### PDP-5 DELEGATE

C. H. P. Brookes  
Central Research Laboratory  
Broken Hill Pty. Co. Ltd.  
Shortland, N.S.W. Australia

#### PDP-7 DELEGATES

David R. Ellis  
Electronic Associates, Inc.  
Princeton, New Jersey

James H. Murren  
Jet Propulsion Laboratory  
Pasadena, California

John V. Oldfield  
University of Edinburgh  
Edinburgh, Scotland

A. Neil Pappalardo  
Massachusetts General Hospital  
Research Computer Center  
Boston, Massachusetts

Peter J. Twin  
Chadwick Physics Laboratory  
Liverpool University  
Liverpool, England

#### PDP-8 DELEGATES

Victor Berecz, Jr.  
Sikorsky Aircraft  
Stratford, Connecticut

Jaan Kruus  
University of Ottawa  
Ottawa, Ontario

Jon Mark  
Donnar  
Canadian Westinghouse  
Hamilton, Ontario

Ted R. Shelor  
GD/Convair  
San Diego, California

Arthur G. Snapper  
Psychophysiological Stress Laboratory  
FDR VA Hospital  
Montrose, New York

# NEW DECUS MEMBERS

## PDP-8 DELEGATES (Continued)

Judson Spencer  
University of Michigan  
High Altitude Laboratory  
Ann Arbor, Michigan

Roger Trudeau  
M.I.T. Instrumentation Laboratory  
Cambridge, Massachusetts

## LINC DELEGATE

Donald S. Blough  
Department of Psychology  
Brown University  
Providence, Rhode Island

## INDIVIDUAL MEMBERS

Bo Arven  
Jaktstigen 3  
Ekerö, Sweden

Miss Pc Berry  
National Gas Turbine Establishment  
Farnborough, Hants, England

Claude Bouthier  
Thomson Houston  
Gennevilliers, Seine, France

J. Alan Bowie  
Standard Telephones and Cables Ltd.  
Hertfordshire, England

Miss V. I. Burton  
P.H.P. Central Research Laboratories  
Shortland, N.S.W. Australia

Barton L. Caprario  
American-Standard Research Laboratory  
New Brunswick, New Jersey

William H. Calvin  
University of Washington School of Medicine  
Department of Physiology & Biophysics  
Seattle, Washington

J. B. Carroll  
Deutsches Elektronen Synchrotron  
Notkestieg 1, Germany

## INDIVIDUAL MEMBERS (Continued)

Bernard Cohen  
Standard Telephones and Cables Ltd.  
Hertfordshire, England

Ralph J. Cormier  
U.S. Rubber Tire Co.  
Detroit, Michigan

Michael L. D'Addio  
Northeastern University  
Hyde Park, Massachusetts

Pauline Mary Erskine  
National Gas Turbine Establishment  
Pyestock, Nr. Farnborough  
Hampshire, England

B. R. Gaines  
Psychological Laboratory  
Cambridge, England

Barbara Graddis  
RCA Communications  
New York, New York

A. L. Inderbitzen  
Lockheed-California Company  
San Diego, California

Timothy J. Kirby  
Learning Research & Development Center  
University of Pittsburgh  
Pittsburgh, Pennsylvania

Oscar Schoo Lastra  
The Danish Atomic Energy Commission  
Roskilde, Denmark

Ralph Graham Corlis  
B.H.P. Central Research Laboratories  
Shortland 2N  
Newcastle, N.S.W. Australia

Charles W. Lewis  
University of Liverpool  
Chadwick Laboratory  
Liverpool, England

John H. Lines  
National Gas Turbine Establishment  
Pyestock, Farnborough  
Hants, England

Henry S. Littleboy  
Stanley Cobb Laboratories  
Massachusetts General Hospital  
Boston, Massachusetts

Curt Marble  
Massachusetts General Hospital  
Research Computer Center  
Boston, Massachusetts

Christopher Stephen Martin  
Learning Research  
& Development Center  
University of Pittsburgh  
Pittsburgh, Pennsylvania

Marilyn S. Ressler  
Electronic Associates, Inc.  
Princeton, New Jersey

Ronald J. Shamblin  
Washington University  
St. Louis, Missouri

Malcolm H. Slade  
Brookhaven National Laboratory  
Upton, New York

E. B. Toulmin-Rothe  
Calab Associates  
Wilton, Connecticut

Frank V. Ventura  
Chase Brass & Copper Company  
Cleveland, Ohio

George A. Wallace  
Standard Telephone & Cables Ltd.  
Cockfosters, Barnet  
Herts, England

John Russell Williams  
B.H.P. Central Research Laboratories  
Shortland 2N, N.S.W. Australia

Robert J. Wright  
The University of Western Australia  
Nedlands, Western Australia

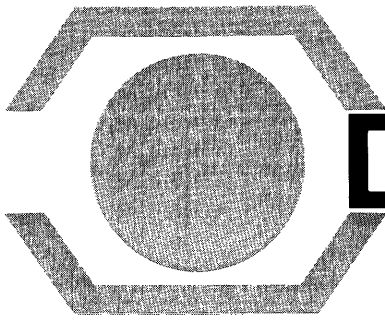

# DECUSCOPE

DIGITAL EQUIPMENT COMPUTER USERS SOCIETY

1966  
Vol. 5 No. 7

## COMPUTER AIDS TO THE HANDICAPPED THE PDP-8 AS A BRAILLE TRANSLATOR\*

Henry S. Magnuski  
Project MAC, M.I.T.  
Cambridge, Massachusetts

This article reports on work being done on a computer translated Braille equivalent of a Teletype machine used to translate English text into Grade I and Grade II Braille. The work is being performed at M.I.T., Project MAC and a paper on the subject was presented at the Spring DECUS Symposium held in Boston.

The M.I.T. Brailer, as it is called, is a machine which can emboss Braille cells at a rate of 10-15 characters per second. This machine, coupled through a special interface on the PDP-8 makes high quality Braille text available to the user of the computer, and to blind users of M.I.T.'s time-sharing system. The PDP-8 can also be connected to the outside world via a Dataphone link, thus supplying Braille translation from remote locations.

### The Braille Language

In 1826 a Frenchman named Louie Braille came across a method that a French military general had invented for sending messages at night. Braille developed this method into a system for embossing paper with a series of dots so that blind persons could read through the use of their sense of touch. Since that time the use of Braille has become widespread in the United States and elsewhere and two basic forms of Braille have developed. These two forms are known as Grade I and Grade II Braille. This article discusses some of the problems involved in translating English text into these two grades of Braille through the use of a small computer, and it will also describe the work being done at M.I.T.'s Project MAC which is making computer translated text available to the blind.

The translation of English text into Grade I Braille is fairly straightforward, and, with only a few exceptions, it simply requires the substitution of the Braille equivalent for the characters in the English text. One of these exceptions, for example, is the use of the numeral sign before a string of numbers. The Braille symbols for the digits are identical to some of the letters, and in order to avoid confusion, a num-

eral sign has to be used to indicate that the string of characters which follow the numeral sign is a number. Another exception to the rule is the one-to-many translation of certain graphics.

The equals sign, for instance, requires two symbols of Braille for its representation and the percent sign requires three. Despite these special cases, the translation can be done very easily by a small computer, and the translated text would look like the top portion of Figure 1.

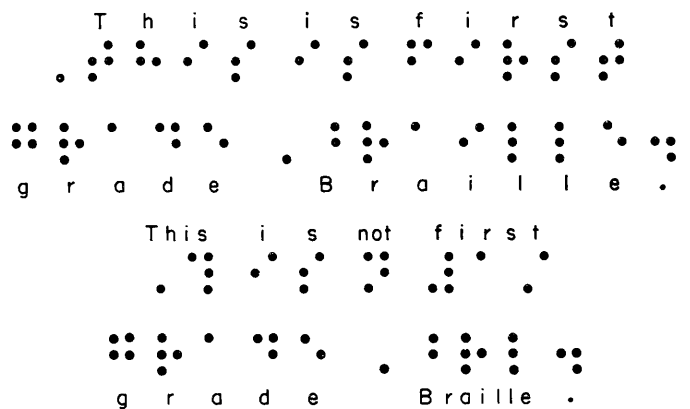

Figure 1 Samples of Grade I and Grade II Braille Translation

Grade II Braille, on the other hand, is much more complex and contains many contractions and special rules. The bottom portion of Figure 1 illustrates some of these features. Notice, in the first word of the sentence the capital sign still remains, but the entire word "this" has been contracted to a single Braille symbol. "Is" and "grade" are identical in the Grade I and Grade II translations but "first" and "Braille" have been contracted. Also, "not" has its own abbreviation.



A problem which arises in Braille translation, as with many other mechanical translation schemes, is the context sensitivity of the translation. The letters "th" have an abbreviation in Braille when used in a word such as "mother". The "th" combination also appears in sweetheart, but the use of the "th" contraction in this case is illegal. A computer program which would handle a majority of these cases and still fit into the 4K memory in the PDP-8 was written by Fred Luconi at M.I.T.<sup>1</sup>

### The M.I.T. Braille

Needless to say, without some means of embossing the translated Braille on paper, the translation itself is not very useful. There have been a number of attempts to emboss Braille through the use of computer controlled equipment, primarily through the modification of standard line printers. During the past few years, however, several groups at M.I.T. have been developing a Braille embosser which is almost the equivalent of a standard Teletype machine.

The original design of the M.I.T. Braille was done by Daniel Kennedy at M.I.T. under the guidance of Professor D. M. B. Baumann.<sup>2</sup> Adding to the original design, A. Armstrong built a housing for the embosser so that the Braille could be used as a remote terminal.<sup>3</sup> The Sensory Aids Development and Evaluation Center helped to test the mechanical operation of the embosser, and the author, under the direction of Professor E. L. Glaser, helped to check out the electronics' interface between the Braille and the PDP-8 and write whatever test and maintenance programs necessary to assure proper functioning of the machine.

This work was sponsored by the Advanced Research Projects Agency of the Department of Defense, and by the Vocational Rehabilitation Administration of the Department of Health, Education and Welfare.

This Braille can now emboss 10-15 characters a second, and programs exist which will accept input from the Teletype and translate the English text into Grade I and Grade II Braille. There is also a program which will receive signals from the Dataphone connected to the PDP-8 and turn these Teletype signals into Grade I Braille. The Braille is shown in Figure 2.

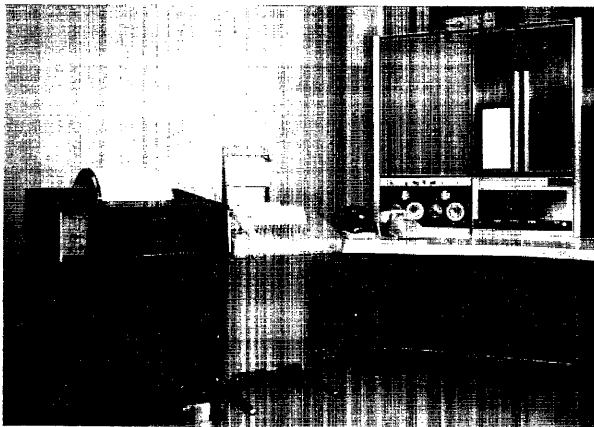

Figure 2  
The M.I.T. Braille and PDP-8 Computer

### The Braille and Real-Time Translation

One of the main reasons why the Braille was designed as an equivalent for a Teletype unit is to allow the Braille to be used as part of an on-line communications terminal. Figure 3 illustrates the use of the Braille and the PDP-8 in this type of situation. The Braille is completely controlled by the PDP-8, and all translation is done by the small computer. The PDP-8 connects to the M.I.T. time-sharing system through a standard Dataphone set, and the only information which is exchanged between the 7094 computer and the PDP-8 is standard English text. The PDP-8 acts as a small satellite processor in this case, taking the output from the 7094 and converting it into a form suitable for a blind programmer. This system allows blind people to enjoy the benefits of time sharing, and it also allows the Braille to make translations of text which is being entered from remote locations in the system.

### Uses for the Braille Translation System

The computer based Braille translation system described has a number of interesting applications. First, of course, is the ability to produce readable Braille without use of a skilled translator. Any skilled typist can generate documents in Braille through use of the PDP-8 and the Symbolic Tape Editor program. The error-free paper tape of the document can be given to the Braille translation program thus producing the completed document. Copies of this document can be made merely by running the paper tape through the translation program again.

The ability to convert to a time-shared computer system has been mentioned. Besides the normal benefits of time sharing, there is one feature in the time-shared system which is especially suitable for use with the Braille. This special feature is the ability to generate and annotate Braille manuscripts. Correcting and editing a Braille document can be very difficult, due to the fact that writing in the margins and squeezing in extra lines is not permitted. The manuscript editing programs eliminate these restrictions and provide all the conveniences of electronic editing.

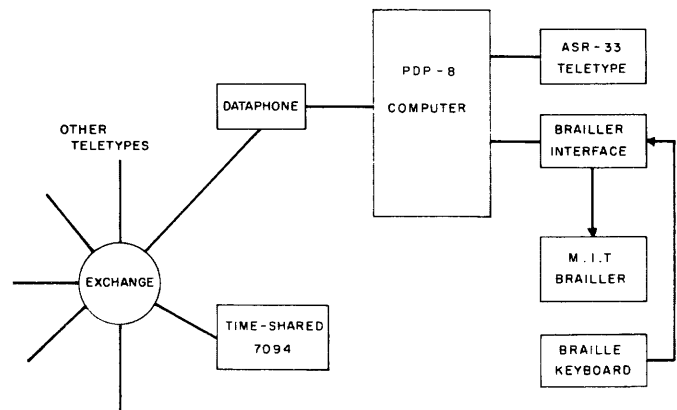

Figure 3  
Block Diagram of Braille Translation System

With the increasing availability of documents in machine sensible form (on paper or magnetic tape), the work involved in preparing the manuscript for translation has been eliminated. At Project MAC the research group working on the new Multics time-sharing system has virtually all of its internal documents on paper tape, and this tape can be converted directly into Braille text. This greater availability of text will undoubtedly open new opportunities for blind people, especially in the computer field where machine sensible text is quite common.

#### Future Plans

The next addition to the Braille system will be a special Braille keyboard. Although many blind people know how to type well, the task of writing in English and reading in Braille has been found to be rather annoying. To overcome this problem a special Braille keyboard has been designed and is about to be tested on the Braille. This keyboard is similar to those used on standard Braille typewriters, and allows the user to emboss Braille without removing his fingers from the keys.

We look forward to increasing and improving our translation capabilities, and hope that in the near future we will have programs available to translate most common sources of text. We are interested in knowing about other Braille translation efforts, and are willing to attempt translation of documents for those who need them if these documents are available on tape or in some other suitable form.

Automatic Braille translation schemes, such as the one reported here, will probably become more widespread in the future as an aid to the handicapped. Today there are 415,000 legally blind people in the United States, and over 100 of these are already involved in the computer field. The greater availability of documents will undoubtedly help these people lead more productive and satisfying lives.

#### References

1. Luconi, Fred L., "A Real Time Braille Translation System", S. M. Thesis, Electrical Engineering Department, M.I.T., June 1965.
2. Kennedy, D. W., "A High Speed Braille Embossing System", S. M. Thesis, Mechanical Engineering Department, M.I.T., May 1963.
3. Armstrong, Allen E., "A Braille Telecommunications Terminal", S. M. Thesis, Mechanical Engineering Department, M.I.T., June 1965.

\*Work reported herein was supported by Project MAC, a M.I.T. research program sponsored by the Advanced Research Projects Agency, Department of Defense, under Office of Naval Research Contract Number Nonr-4102(01), and by the Vocational Rehabilitation Administration of the Department of Health, Education and Welfare.

## DINNER SPEAKER DECUS FALL SYMPOSIUM



Dr. Willard H. Wattenburg

Dr. Willard H. Wattenburg will be the dinner speaker at the DECUS Fall Symposium to be held at Lawrence Radiation Laboratory, Berkeley, California on November 4th and 5th. The topic of his talk, "A World Full of Time Bombs" will cover problems associated with reliability of hardware and software. Dinner will be held on Friday evening.

Dr. Wattenburg is currently President of Berkeley Scientific Laboratories, an organization involved in systems design and electronic design of data acquisition systems and computer systems.

He received his BS from Chico State College and his MS and Ph.D. from the University of California, Berkeley, in Electrical Engineering. He has taught at Chico State College and at the University of California, Berkeley, and has been associated with the Lawrence Radiation Laboratory, Livermore; the General Electric Company; and Bendix Computer.

Dr. Wattenburg has been a consultant to Bellcomm, Inc., where he prepared specifications for the computer controlled APOLLO checkout system, and to Lockheed Missiles and Space Company, Sunnyvale, where he constructed operating and program systems for the Lockheed computing center; helped develop the 7090 NELIAC compiler, and participated in the systems design of NASA's real-time data reduction center in Houston. His many published works include articles on compiling techniques, automatic programming systems, computerized blood bank control, automated translator construction, and computer controlled analysis of bacterial colonies.

# NOMINATIONS FOR OFFICE

The following DECUS members have been nominated for office:

## Programming Chairman

Richard McQuillin  
Inforonics, Incorporated  
Maynard, Massachusetts

## Equipment Chairman

Sypko Andrae  
Lawrence Radiation Laboratory  
Berkeley, California

## Publications Chairman

Joseph Lundy  
Inforonics, Incorporated  
Maynard, Massachusetts

Edward Della Torre  
American-Standard Research Division  
New Brunswick, New Jersey

Michael D. Perry  
University of Alabama Medical Center  
Birmingham, Alabama

Nomination sheets were sent to all members and the nominations closed on July 30th. Official ballots are being sent to all delegates. A short biography on each candidate follows:

### RICHARD J. MC QUILLIN

Mr. McQuillin earned a B.S.C. (1955) at the University of Puget Sound, and a M.S.C. (1959) at Brown University. His major fields were Mathematics and Physics.

He joined the staff of Bolt Beranek and Newman, Inc. in 1958, specializing in physical acoustics. The earliest computer experience was with an LGP-30, where his work involved writing a compiler to process complex algebraic statements. When BBN acquired the first PDP-1 computer, Mr. McQuillin's interests turned to this machine. Major computer activities included work on the Floating Point Package (DECUS No. 10), and on DECAL-BBN (DECUS No. 39). He headed the work on the DECAL-BBN Project.

Since June 1964, Mr. McQuillin has been associated with Inforonics, Incorporated, where he is presently director of programming systems. His major interests include computer-aided publishing as well as computer languages. In addition to his current work on the specifications and implementation of programming languages, Mr. McQuillin is working on the development of a typesetting language for the computer composition of complex structures, such as Mathematical displays and chemical ring structures.

He has been an active member of DECUS for four years, serving as Programming Chairman for the past three years. During that time he has become active in the Joint Users Group, JUG, the association of all the user groups. During the past year he served as Chairman of the JUG/DECUS Workshop and is currently Chairman of the Ad Hoc JUG Program Library Catalog Committee.

### SYPKO W. ANDRAE

Sypko received training in electrical engineering at Delft University, The Netherlands and earned his masters degree in 1960. His studies were interrupted for two years which he spent in the Royal Dutch Air Force as a weather forecaster.

He worked as a junior engineer with T.N.O. Physics Laboratory near The Hague on several aspects of logic design and spent a short time with ISYS and Philips Physics Laboratories before emigration to California. He has since worked at Univ. of California, Lawrence Radiation Laboratory, in systems design for the data acquisition of high-energy experiments and related subjects.

### JOSEPH LUNDY

Mr. Lundy is presently head of Text Processing Systems at Inforonics, Incorporated. He is engaged in development of computer systems for recording and machine processing of bibliographic and textual data to produce printed publications and permanent information files for retrieval. His interests include computer techniques for editing and correcting text.

Prior to his present position, Mr. Lundy was a member of the research programming group at Itek Corporation where he worked on programs for experimentation in automatic word coding techniques. He performed a study on the applicability of the Stenotype recorder to on-line computer input. Mr. Lundy designed and programmed a CRT editing system for textual and graphic information.

Before joining Itek, Mr. Lundy served in the Data Processing Branch of the Adjutant General's Office at The Pentagon, Washington, D.C.

Mr. Lundy is a member of the American Documentation Institute. He received his A.B. in English at Boston College in 1958.

### EDWARD DELLA TORRE

Dr. Della Torre attended Polytechnic Institute of Brooklyn where he received his B.E.E. degree cum laude in 1954. He earned his M.S. degree in Electrical Engineering from Princeton University in 1956, and a M.S. degree in Physics from Rutgers University in 1961. He was awarded the Eng. Sc.D. in Electrical Engineering from Columbia University in 1964.

He joined the faculty of the Electrical Engineering Department of Rutgers University in 1956 as an Associate Professor. Dr. Della Torre was associated with Western Electric Company in New York City; Minneapolis-Honeywell Corporation in Beltsville, Maryland; and the Radio Corporation of America, David Sarnoff Research Center in Princeton, New Jersey. At present he is a consultant to the staff of the American-Standard Research Laboratory.

He is the author of numerous articles on magnetic materials and electromagnetic theory, and is also co-author of a forthcoming book on electromagnetic fields.

Dr. Della Torre is a senior member of the IEEE, Sigma Xi, and Eta Kappa Nu.

#### MICHAEL D. PERRY

Mr. Perry is presently working as a research investigator with a team of medical doctors whose primary project is the N.I.H. Grant: "Cardiovascular Investigations using Digital Computers." His responsibilities include: selection or design and integration of electronic instrumentation, coordinator of the Cardiovascular PDP-7 digital computer, and interface between the M.D.'s and the electronic state-of-the-art and is also teaching upper-division electrical engineering courses at the Birmingham Engineering Center.

He earned his B.S.E.E. at the University of Utah in June 1956 and his M.S.E.E. at the University of Southern California in January 1960. He is currently working toward a doctorate in Physiology at the University of Alabama.

His past experience includes: Chief Systems Engineer, Engineering Division, Hayes International Corporation, Birmingham, Alabama; Engineering Specialist, Advanced Missiles Branch, Northrop/Corporation, Hawthorne, California; Member of the Technical Staff, Advanced System Laboratory, Hughes Aircraft Company, Fullerton, California; Part-time Instructor, Mathematics and Engineering Department, Orange Coast College, Costa Mesa, California; Research Engineer, Aeronutronic, Newport Beach, California; Visiting Lecturer, Electrical Engineering Department, University of Southern California, Los Angeles, California; and Research Engineer, Autonetics Division, North American Aviation, Los Angeles Area, California.

Mr. Perry is a registered professional engineer.

---

#### EDITOR'S NOTE

The article, "Computer-Interfaced Multichannel Pulse-Height Analyzer for Nuclear Data" by Philip R. Bevington, Stanford University, which appeared in DECUSCOPE issue Vol. 5, No. 5, is soon to be published also in NUCLEAR INSTRUMENTS AND METHODS.

## NEW DECUS MEMBERS

### PDP-1 DELEGATE

Nancy E. Lambert  
Bolt Beranek and Newman Inc.  
Cambridge, Massachusetts

### PDP-6 DELEGATE

R. Prescott  
Imperial College  
London, S.W. 7, England

### PDP-7 DELEGATES

John Holland  
The University of Michigan  
Ann Arbor, Michigan

Prof. Dr. R. T. Van de Walle  
Fysisch Laboratorium  
Nijmegen, Netherlands

Takekora Yamagata  
University of Tokyo  
Tokyo, Japan

### PDP-8 DELEGATES

A. H. Albert  
Chrysler Engineering Office  
Detroit, Michigan

E. F. Anelli  
Universita' Di Bari  
Bari, Italy

Richard D. Benton  
Mississippi State University  
Gulfport, Mississippi

Ronald N. Borgers  
Lawrence Radiation Laboratory  
Livermore, California

Mr. Carton  
COSEM  
38 Saint Egreve, France

David Dewhurst  
University of Melbourne  
Parkville, N.2, Victoria, Australia

Richard C. Hewitt  
Bell Telephone Laboratories  
Murray Hill, New Jersey

Howard C. Johnson  
Bell Telephone Laboratories  
Holmdel, New Jersey

Hugh W. Jones  
The Mason Clinic  
Seattle, Washington

Continued on Page 10

# COMPRESSED READ-IN MODE PAPER TAPE LOADER FOR THE PDP-8 (CRIMP)

Nick Chase  
C. W. Adams Associates  
Cambridge, Massachusetts

CRIMP is a small paper tape loader program which occupies the same space in core as the PDP-8 RIM loader, but allows tapes in a condensed format to be read.

data word. CRIMP will store consecutive data words in consecutive memory locations until a new address is encountered. CRIMP will also read ordinary RIM tapes.

The paper tape to be read is in CRIMP format:

```

10000.000 )
10000.000 ) leader-trailer code
01aaa.bbb ) starting address for block
00ccc.ddd ) storage of data words following
00www.xxx ) contents of starting address
00yyy.zzz )
00www.xxx ) contents of address + 1
00yyy.zzz )
(etc)
10000.000 )
10000.000 ) leader-trailer code
  
```

The CRIMP format is identical to the RIM format, except that it is not necessary to specify a new address before each

Each CRIMP paper tape may end with a jump block. This has the format:

```

01111.111 )
00111.111 ) address 7777
00xxx.xxx )
00xxx.xxx ) contents of location 7777
  
```

When CRIMP sees the jump block, it leaves the read-in loop and goes to location 7777, which would normally be a halt, or a jump to the start of the program. If no jump block is given, location 7777 is undisturbed.

To use CRIMP with extended memory, the instruction field switches should be set to the memory field in which the CRIMP loader is located, and the data field switches set to the module where the program on paper tape is to go.

The CRIMP loader: (SA = 7772)

7756	6036	RDFRST,	KRB	/READ FIRST CHARACTER OF WORD
7757	7166		CMA STL RTL	/COMPLEMENT AND ROTATE
7760	7146	RDWD,	CMA CLL RTL	/ROTATED ORIGINAL OR 7775
7761	6031		KSF	/WAIT FOR NEXT CHARACTER
7762	5361		JMP .-1	/TO BE ASSEMBLED IN BUFFER
7763	7510		SPA	/IF CHANNEL 8 = 1,
7764	5356		JMP RDFRST	/TAPE FEED OR SYNC WORD
7765	7006		RTL	/CHANNEL 7 INTO LINK
7766	6034		KRS	/SECOND CHARACTER TO COMPLETE
7767	7430		SPL	/IF CHANNEL 7 = 1,
7770	3376		DCA WDLOC	/THIS IS AN ADDRESS
7771	3776		DCA I WDLOC	/WORD OR ZERO AS CONTENTS
7772	6032	BEGIN,	KCC	/PREPARE FOR NEXT CHAR
7773	7420		SML	/IF THIS WAS DATA WORD,
7774	2376		ISZ WDLOC	/INDEX ADDRESS TO NEXT LOCATION
7775	5360		JMP RDWD	/RECYCLE TO READ NEXT WORD
7776	7776	WDLOC,	. .	/ADDRESS FOR DATA WORD STORAGE
7777	7777	JWORD,	. .	/JUMP BLOCK WORD

DIGITAL EQUIPMENT CORPORATION  
INTRODUCES NEW PDP-9

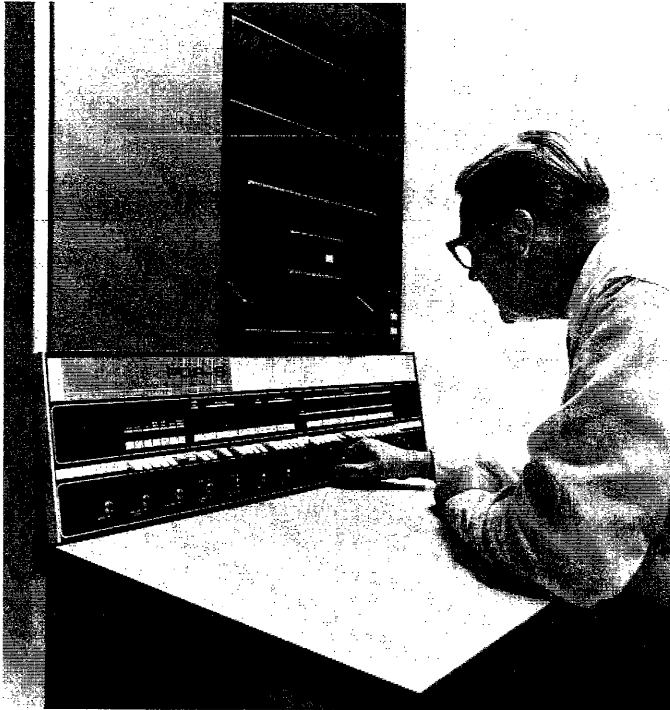

The PDP-9, the largest general purpose digital computer in the low cost field, has been introduced by Digital Equipment Corporation.

Priced at \$35,000, the basic PDP-9 includes 8,192 words of 18-bit ferrite core memory, a 300-character-per-second paper tape reader, a 50-character-per-second paper tape punch, a console teleprinter, a direct memory access channel, four data channels, and a real-time clock.

The PDP-9 is designed for on-line and real-time scientific, engineering and process control applications. It features a 1.0 microsecond cycle time, a 2.0 microsecond add time, input/output transfer rates up to 18,000,000 bits per second and a modular software package that expands to take full advantage of all hardware configurations. Memory can be expanded in 8,192 word increments to 32,768 words.

The PDP-9 offers more power and versatility than any other computer in its price range. Its 18-bit word length provides single word addressing of a full 8,192 word memory module and easy addressing of a full 32,768 word memory. New advanced memory techniques are used to significantly reduce the cost of the core memory. By using a fast core logic control memory to decode instructions, control register gating and timing, and to generate major states, the PDP-9 is able to attain significant increases in reliability while reducing the cost of the central processor. A new high-speed parallel adder has been designed to serve as the path between all active registers. This adder can combine two 19-bit words in 200 nanoseconds.

The fully parallel PDP-9 employs binary arithmetic, parallel transfers and permits auto-indexing and indirect addressing. A sophisticated automatic priority interrupt system is used to

provide immediate recognition of nested hardware and software interrupts. The PDP-9 is constructed entirely from - and interfaces easily with - hybrid integrated circuits from Digital's FLIP CHIP™ module line.

With powerful standard features such as 8,192 words of memory, high-speed paper tape I/O, and an automatic loading feature, the PDP-9 is able to offer powerful versatile software for basic systems. This software package, which expands to use all central processor options and memory includes real-time FORTRAN IV, a macro assembler, a control monitor, six and nine digit floating point arithmetic packages, an on-line editor, an on-line debugging system, and a modular input/output programming system.

Mass storage devices such as low cost DECTape, IBM compatible magnetic tape, disks and drums are available as PDP-9 options along with a variety of other input/output devices and central processor features. Four different display systems will also be available as PDP-9 options.

Initial orders for the PDP-9 indicate wide acceptance in such diverse applications as physics, biomedicine, process control, chemical instrumentation, display processing, and data communications. In many of these applications, the PDP-9 will be interfaced to large computation center facilities.

With first deliveries in December, 1966, the PDP-9 expands Digital's family of low priced computers which include the new \$10,000 PDP-8/S, the \$18,000 PDP-8 and the LINC-8, the complete laboratory computer.

PDP-8/S — UNDER \$10,000  
FULL SCALE COMPUTER ANNOUNCED



PDP-8/S, the first full-scale general purpose core memory

digital computer to sell for under \$10,000 has been announced by Digital Equipment Corporation.

It is designed for use as an independent information handling facility in a larger computer system, or as a control element in a complex processing system. The PDP-8/S is a one-address, fixed word length, serial computer using a word length of 12-bits plus parity and two's complement arithmetic. Cycle time of the 4096-word random address magnetic core memory is 8 microseconds. Standard features of the system include indirect addressing and facilities for instruction skipping and program interruption as functions of input/output device conditions.

Addition is performed in 36 microseconds with one number in the accumulator. Subtraction is performed in 64 microseconds with the subtrahend in the accumulator. Multiplication is performed in approximately 5.35 milliseconds by a subroutine that operates on two signed 12-bit numbers that produce a 24-bit product, leaving the 12 most significant bits in the accumulator. Division of two signed 12-bit numbers is performed in approximately 7.38 milliseconds by a subroutine that produces a 12-bit remainder in core memory.

Flexible, high capacity, input/output capabilities of the computer operate a variety of peripheral equipment. In addition to standard teletype and perforated tape equipment, the system can operate in conjunction with all non-data break optional devices offered in the PDP-8 family line. Equipment of special design is easily adapted for connection into a PDP-8/S system. The computer is not modified with the addition of peripheral devices.

A single source of 115-volts, 60 cycle, single phase power operates the machine. An internal power supply produces all of the required operating voltages. Standard FLIP CHIP Modules using hybrid silicon circuits insure reliable operation in ambient temperatures between 32 and 130 degrees Fahrenheit.

The PDP-8/S consists of a central processor, a memory unit, and input/output equipment and facilities. All arithmetic, logic, and system control operations of the standard PDP-8/S are performed by the processor. The central processor and memory are independent and asynchronous. The processor requests memory cycles only when required, each memory cycle consisting of a read followed by a write operation. Input and output addresses and data buffering for the core memory are performed by registers of the processor, and operation of the memory is under control of its own timing logic.

Interface circuits for the processor allow bussed connections to a variety of peripheral equipment. Each input/output device is responsible for detecting its own selection code and for providing any necessary input gating. Individually programmed data transfers between the processor and peripheral equipment take place through the processor accumulator. Standard features of the PDP-8/S also allow peripheral equipment to perform certain control functions such as instruction skipping, and a transfer of program control when initiated by a program interrupt.

# DECUS PROGRAM LIBRARY

## PDP-1 PROGRAM LIBRARY ADDITIONS

### DECUS No. 90

Title: Color Debugger

Author: Nick Chase, C. W. Adams Associates, Inc.,  
Cambridge, Massachusetts

Color Debugger is a program providing on-line debugging in octal using a PDP-1 computer with color display and pushbutton. It has two basic modes: examine/modify, and program trace, and is especially useful for remote display consoles.

The program requires a PDP-1 with memory extension control and a color display console, or a black and white Type 30 Display (preferably with pushbuttons connected to the computer testword). Two read-in mode tapes are available, one occupying 3150-3777, the other 7150-7777.

## PDP-4 PROGRAM LIBRARY ADDITIONS

### DECUS No. 4-14

Title: CCS Operator System

Author: Harry Rudloe, Harvard University, Cambridge,  
Massachusetts

CCS Operator System allows one to perform a variety of DECtape operations under control of the Teletype. The principal functions are:

1. writing records
2. reading records
3. searching for records
4. logging a tape to have the names of all records listed on the Teletype
5. erasing tape

The Operator System also contains a complete package of Teletype and DECtape routines which are rendered available for use by the programmer. In addition, a package called the Operator Extension is provided which contains subroutines for the reader, punch and input-output of FIO-DEC text from the Teletype. The basic Operator System + The Operator Extension will be referred to as The Extended Operator.

Programming Language: PDP-4 Assembler

Storage Used: ~~0~~ - ~~4000~~ for basic Operator System  
~~4000~~ - ~~5760~~ for Operator Extension

Special Hardware Used: Type 28 Teletype, DECtape Unit,  
Single Channel Interrupt

#### DECUS No. 4-15

Title: CCS Scope Editor

Author: Harry Rudloe, Harvard University, Cambridge, Massachusetts

The CCS Scope Editor is a program for rapid editing of textual materials, particularly symbolic programs. Selected portions of a text are displayed on the 340 Scope and edited under control of the Teletype and light pen. Its in-out operations involve only the paper tape reader and punch and the Teletype.

Storage Used: Requires all of memory (8K), but is easily modified for 4K machines.

Special Hardware: Type 340 Scope with Type 342 Symbol Generator, Type 28 Teletype, Reader and Punch and Single Channel Interrupt.

Restrictions: The program will process FIO-DEC symbolic tapes only.

Subroutines Required: The binary tape provided must be loaded with the two binary tapes of the Extended Operator System (DECUS No. 4-14) and the symbolic tapes must be assembled with the Extended Operator Pundefs and the 5760 Start Patch.

#### PDP-5/8 PROGRAM LIBRARY ADDITIONS

#### DECUS No. 5/8-43

Title: Unsigned Octal - Decimal Fraction Conversion

Author: Frank Ollie, Defence Research Telecommunications Establishment, Shirley Bay, Ottawa, Canada

This routine accepts a four-digit octal fraction in the accumulator and prints it out as an N-digit decimal fraction where N = 12 unless otherwise specified. After N digits, the fraction is truncated. Programs are included for use on the PDP-5 with Type 153 Automatic Multiply-Divide and the PDP-8 with Type 182 Extended Arithmetic Element.

Storage Requirements:

55 octal locations for the PDP-5  
47 octal locations for the PDP-8

#### DECUS No. 8-44

Title: Modifications to the Fixed Point Output in the PDP-8 Floating Point Package (Digital 8-5-S)

Author: Standard Telephone and Cables Limited, Cockfosters (Barnet), Herts, England

The Floating Point Package (Digital 8-5-S) includes an Output Controller which allows output in fixed point as well

as floating point format. This Output Controller takes the form of a certain number of patches to the "Floating Output E Format" routine, plus an additional page of coding.

Using the Calculator program (Digital 8-10-S), which includes the Floating Point Package, certain deficiencies were noted in the fixed-point output format, particularly the lack of any automatic rounding off. For example, the number 9, if outputted as a single digit, appears as 8. Modification attempts to provide automatic rounding off resulted in the Output Controller being completely rewritten with minor changes in the format.

This new version of the Output Controller is also in the form of patches to the Floating Output with an additional page of coding, thereby not increasing the size of the Floating Point Package.

The following summarizes this new version:

1. The number output is automatically rounded off to the last digit printed, or the sixth significant digit, whichever is reached first. Floating point output is rounded off to six significant figures since the seventh is usually meaningless.
2. A number less than one is printed with a zero preceding the decimal point (e.g. "+0.5" instead of "+.5").
3. A zero result, after rounding off, is printed as "+0" instead of "+".
4. The basic Floating Point Package includes the facility to specify a carriage return/line feed after the number using location 55 as a flag for this purpose. The patches for the Output Controller caused this facility to be lost. This version restores this facility.

#### PDP-7 PROGRAM LIBRARY ADDITIONS

#### DECUS No. 7-18

Title: Paper Tape Verifier

Author: P. F. Niccolai, Carnegie Institute of Technology, Saxonburg, Pennsylvania

Storage: 330g program  
331g-17713g master tape

Needed: PDP-7 with 8K memory and EAE Master Tape + duplicate tape

Paper Tape Verifier verifies each line of a master tape against its corresponding line on a duplicated paper tape. The master tape is read into the computer and stored two lines per word in memory. Two lines of the duplicated paper tape are then read and compared with their corresponding lines on the master tape in memory. In the event of an error, the contents of the two lines from the duplicated paper tape are typed in octal and, immediately below, the contents of the same two lines on the master tape are also typed in octal.



DECUS No. 7-19

Title: DUMP ND 180 and FDUMP ND 180

Author: Phillip Bevington, Stanford University, Stanford, California

Storage Required:

226<sub>8</sub> (Dump ND 180)

264<sub>8</sub> (FDump ND 180)

DUMP ND 180 is a Fortran subroutine for the PDP-4/7 to transfer a data spectrum from the memory of a Nuclear Data 180 (or 181) multichannel pulse-height analyzer and deposit it in a specified matrix in fixed point mode.

The data are read in BCD mode and truncated modulus 100,000 before conversion to binary. The 18 least significant BCD bits (i.e., totalling less than 40,000) are checked after reading, but not the two most significant.

Data are read during display on the CRT of the analyzer. The reading is completely passive in that no signals are sent from the computer to the analyzer. If the analyzer is not in the display mode, the subroutine will loop and wait for it.

FDUMP ND 180 is a Fortran subroutine for the PDP-4/7 for transferring a data spectrum from the memory of a Nuclear Data 180 (or 181) multichannel pulse-height analyzer and deposit it in a specified matrix in two-word floating point mode.

The data are read in BCD mode and checked (but not truncated) before conversion to floating point mode. All bits are checked. Data are read during display mode of the analyzer as outlined for DUMP ND 180.

This subroutine is written in mixed Fortran and PDP-4/7 symbolic and utilizes EAE instructions. Skip on channel ready flag=703001; read least significant BCD bits=703016; read most significant bits (right justified) and most significant bits of address (bits 1-4) = 703056.

DECUS No. 7-20

Title: DECTape Copy Routine

Author: James D. Pitts, III, Digital Equipment Corp., Maynard, Massachusetts

Needed: Verified DECTape reels for the PDP-4/7, Teletypewriter and DECTape unit 55 or 555 (control 1)

This program will reproduce the data information from one DECTape reel (master) to another (copy) and verify such information. A tape on which timing and mark tracks are written should be used. The program uses the PDP-4/7 DECTape subroutines (Digital 4/7-22-10).

The complete tape of 576 blocks may be copied, or the blocks desired to be reproduced can be designated by the operator through the AC SWS. Data can be copied in multiples of one block only. The blocks indicated in the AC SWS will be copied from the master reel to the corresponding blocks of the copy reel.

## NEW DECUS MEMBERS (Continued)

PDP-8 DELEGATES (continued)

Paul M. Kintner  
Airborne Instrument Laboratory  
Melville, Long Island, New York

Arthur H. Kurz  
Rocketdyne, Division of N.A.A.  
Canoga Park, California

R. W. Lee  
Stanford Electronics Laboratories  
Stanford, California

B. D. Loncarevic  
Bedford Institute of Oceanography  
Dartmouth N.S., Canada

D. M. MacKay  
University of Keele  
Keele, Staffordshire, England

E. E. Maslin  
Herald Reactor, A.W.R.E.  
Berkshire, U.K., England

R. W. McKay  
University of Toronto  
Toronto, Ontario, Canada

M. E. Nordberg, Jr.  
University of Rochester  
Rochester, New York

Myron J. Peskin  
Xerox - Information Systems Division  
Rochester, New York

Ronald E. Rathjen  
Veterans Administration Hospital  
Houston, Texas

James Shanahan  
Electronic Associates Incorporated  
Long Branch, New Jersey

J. Lawrence Tschantz  
Stanford University Hospital  
Stanford, California

---

DECUS No. 7-9

Title: Scope Editor

This program has been revised. It now maintains a circular buffer of approximately 6,000 characters. A new binary tape and writeup are available.

PDP-8 DELEGATES (continued)

Rufus F. Walker, Jr.  
Tufts University  
Medford, Massachusetts

David E. Wells  
Bedford Institute of Oceanography  
Dartmouth, Nova Scotia, Canada

Frank Westervelt  
The University of Michigan  
Ann Arbor, Michigan

Chester D. Wolfe  
Electronic Warfare Division  
Avionics Laboratory  
Wright Patterson Air Force Base, Ohio

Donald R. Wood  
Argonne National Laboratory  
Argonne, Illinois

LINC DELEGATE

James E. Randall  
Northwestern University Medical School  
Chicago, Illinois

338 DISPLAY DELEGATE

Bertram Herzog  
The University of Michigan  
Ann Arbor, Michigan

INDIVIDUAL MEMBERS

W. A. Ainsworth  
University of Keele  
Keele, Staffordshire, England

Nancy R. Baum  
Applied Logic Corporation  
Princeton, New Jersey

Laurence C. Bonar  
Massachusetts General Hospital  
Boston, Massachusetts

John L. K. Brown  
International Telephone and Telegraph Federal Labs.  
Paramus, New Jersey

Anne Bouley  
The Mason Clinic  
Seattle, Washington

Howard A. Cohodas  
Picker X-Ray Company  
Cleveland, Ohio

Leroy A. Dahm  
Electronic Associates, Inc.  
Princeton, New Jersey

INDIVIDUAL MEMBERS (continued)

G. B. Dean  
United Kingdom Atomic Energy Authority  
Berkshire, England

David Fahrland  
Grumman Aircraft Engineering Corporation  
Bethpage, New York

Professor G. Giannelli  
Universita' Di Bari  
Bari, Italy

Leonard M. Hantman  
Adams Associates  
Cambridge, Massachusetts

Robert P. Joiner  
Chevrolet - Bay City Division  
Bay City, Michigan

Murray Vernon King  
Massachusetts General Hospital  
Boston, Massachusetts

Paul E. Lund  
Lawrence Radiation Laboratory  
Livermore, California

G. S. Mani  
Manchester University  
Manchester, U.K., England

M. Marangelli  
Universita' Di Bari  
Bari, Italy

D. A. Moursellas  
The Foxboro Company  
Foxboro, Massachusetts

James F. Muldoon  
Electronic Associates, Inc.  
Princeton, New Jersey

Jay C. Nelson  
Union Carbide Corporation  
South Charleston, West Virginia

Vincent A. Peluso  
Electronic Associates, Inc.  
West Long Branch, New Jersey

Michael D. Perry  
University of Alabama  
Birmingham, Alabama

Keith Alan Paton  
Churchill College  
Cambridge, England

William A. Phillips  
Lawrence Radiation Laboratory  
Livermore, California

INDIVIDUAL MEMBERS (continued)

D. E. M. Scott (Mrs.)  
National Gas Turbine Establishment  
Farnborough, Hampshire, England

Hilton R. Steeves  
Bedford Institute of Oceanography  
Dartmouth, Nova Scotia, Canada

Lee O. Tennant  
Lawrence Radiation Laboratory  
Livermore, California

Richard R. Watson  
Chevrolet - Bay City Division  
Bay City, Michigan

Marvin E. Wiener  
The Foxboro Company  
Brookline, Massachusetts

F. K. Williamson  
Solartron Electronic Group, Ltd.  
Farnborough, Hampshire, England

Martin E. Zimmerman  
Nuclear-Chicago Corporation  
Des Plaines, Illinois

DECUSCOPE is published monthly for Digital Equipment Computer Users Society (DECUS).

Material for publication should be sent to: Angela J. Cossette, DECUS, Maynard, Massachusetts 01754. Telephone: AC 617 897-8821, TWX 710 347-0212

Publications Chairman: Joseph Lundy, Inforonics, Inc.

Circulation: 1,735 copies per month

DECUS acknowledges the assistance of Digital's Technical Publication Department in the preparation of this newsletter.

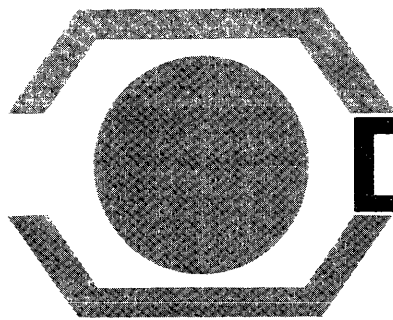

# DECUSCOPE

DIGITAL EQUIPMENT COMPUTER USERS SOCIETY

1966  
Vol. 5 No. 8  
Special Meeting Issue

## DECUS FALL SYMPOSIUM NOVEMBER 4 & 5, 1966 LAWRENCE RADIATION LABORATORY BERKELEY, CALIFORNIA

The Fall Symposium of Digital Equipment Computer Users Society will be held on Friday and Saturday, November 4th and 5th in the Building 50 Auditorium at Lawrence Radiation Laboratory, Berkeley, California. The agenda and abstracts of papers for presentation are contained in this issue. Registration forms and meeting particulars have been sent to all DECUS members. Non-members are invited to attend the meeting as well as the banquet scheduled for Friday evening. Registration forms and meeting information may be obtained by contacting the DECUS office in Maynard, Massachusetts. Those who cannot register in advance may register on Friday or Saturday morning.

Along with a formal presentation of papers, a PDP-6 Discussion Session is planned. Time has been allotted, also, for other computer line discussion sessions. On Saturday, the latter part of the day is open for users to participate in application workshops. Further information on the workshops will be announced at the meeting.

On Friday evening, an attendee dinner has been planned with a guest speaker, Dr. Willard H. Wattenburg of the Berkeley Scientific Laboratories. The subject of his talk is

"A World Full of Time Bombs". Wives and/or husbands are invited to attend the dinner and cocktails preceding.

Headquarters hotel for the meeting is the Hotel Durant in Berkeley, California. Those interested in staying at the hotel during the meeting should make their reservations directly with the hotel, mentioning that you will be attending the DECUS meeting. Reservations, however, should be made with the hotel before October 20th. The hotel cannot guarantee space after that time. They are willing, however, to make alternate accommodations.

DECUS meetings offer an excellent opportunity for users to exchange information, not only through papers, but through personal contact. Members should make a strong effort to attend these meetings and participate whenever possible. Without strong user participation, meetings will lose their value. Please attend if you can!

Inquiries regarding the meetings should be directed to Angela Cossette, DECUS, Digital Equipment Corporation, 146 Main Street, Maynard, Massachusetts 01754.

### SECOND DECUS EUROPEAN SEMINAR

October 25 and 26, 1966

Aachen, West Germany

Additional information and registration forms may be obtained by contacting:

Ray Jones  
Digital Equipment (UK) Ltd.  
11 Castle Street  
Reading, Berkshire  
England

### PLEASE NOTE

Letters sent to members in September regarding the meeting contained the incorrect dates. Dates are November 4th and 5th.

# AGENDA

## FRIDAY - NOVEMBER 4

- 8:30-9:55 Registration
- 10:00 Opening of Meeting  
Professor Donald A. Molony, Chairman
- 10:15 Welcome Address  
Winston R. Hindle, Digital Equipment Corp.
- 10:30 ESI-Conversational Mode Computing for the PDP-8/S  
David Waks, Applied Data Research, Inc.
- 11:00 The BBN On-Line Programming System  
Nancy E. Lambert  
Bolt Beranek and Newman, Inc.
- 11:30 JOSS: Introduction to the System Implementation  
G. E. Bryan, The RAND Corporation
- 12:00 Lunch  
Building 50 Cafeteria
- 1:30 PDP-10 System Philosophy - New Product Announcement  
David Plumer, Digital Equipment Corporation
- 2:15 PDP-6 System at LRL, Livermore  
John G. Fletcher, Lawrence Radiation Lab.
- 2:45 A Common Memory System for a Time-Shared PDP-6  
E. Brazeal and S. Sharpe  
United Aircraft Research Laboratories
- 3:15 Coffee
- 3:30 An Operating System for the PDP-8  
Professor Jacob L. Meiry  
Massachusetts Institute of Technology
- 4:00 PDP-6 Discussion Session (room to be announced)  
General Discussions (meeting room)
- 6:00-7:30 Cocktails  
Hotel Durant - Regents Room
- 7:30 Banquet  
Hotel Durant - Main Dining Room  
Guest Speaker, Dr. Willard H. Wattenburg  
Berkeley Scientific Laboratory

## SATURDAY - NOVEMBER 5

- 9:00-9:30 Registration
- 9:30 Opening of Second Day's Session
- 9:45 On-Line Real-Time Time-Sharing Operation of a PDP-7  
Lloyd Robinson and John Meng  
Lawrence Radiation Laboratory, Berkeley

- 10:15 To be announced
- 10:45 Coffee
- 11:00 PDP-8 as a Data Collector in a Time-Shared System  
Robert Abbott, Institute of Medical Sciences
- 11:30 A PDP-5 Program for Use in Nuclear Counting  
D. R. Thompson, E. E. Wuschke, A. Petkau  
Whiteshell Nuclear Research Establishment
- 12:00 Lunch  
Building 50 Cafeteria
- 1:30 Business Meeting - All Attendees Invited
- 2:00 Flying-Spot Scanner  
Ray Kenyon  
Lawrence Radiation Laboratory, Berkeley
- 2:15 The PDP-6's Role in Analyzing Photographs of Bacterial Colonies  
Fraser Bonnell, MB Virus Laboratory  
University of California
- 2:45 Application of the PDP-5 to Data Handling for Meson Produced X-Rays  
Robert Lafore, University of California, LRL
- 3:15 Coffee
- 3:30 Workshops

## ABSTRACTS

### ESI - CONVERSATIONAL MODE COMPUTING FOR THE PDP-8/S

David Waks  
Applied Data Research, Inc.  
Princeton, New Jersey

At the present time, time-shared computer systems are widely touted as the answer to the problem - "How do we bring the computer to the user?". This paper describes an alternate approach - a JOSS-like system for a minimum PDP-8/S. ESI (8/S interpreter ESI) incorporates virtually all the features of JOSS including conversational mode operation and decimal floating point arithmetic. The system will be demonstrated.

### FLYING-SPOT SCANNER

Ray Kenyon  
Lawrence Radiation Laboratory  
Berkeley, California

A description of the Flying Spot Scanner used with the PDP-6, and associated hardware, at the MB Virus Laboratory, University of California.

## THE PDP-6'S ROLE IN ANALYZING PHOTOGRAPHS OF BACTERIAL COLONIES

Fraser Bonnell  
MB Virus Laboratory  
University of California  
Berkeley, California

A PDP-6 and a Flying-Spot Scanner will be used to analyze photographs of bacterial colonies. This analysis involves finding, sizing, and counting colonies; as well as using "optical density profiles" and colony morphology to identify various organisms.

This project is being carried out in the Molecular Biology Department at the University of California.

## JOSS: INTRODUCTION TO THE SYSTEM IMPLEMENTATION

G. E. Bryan  
The RAND Corporation  
Santa Monica, California

The paper will discuss JOSS, a time-shared computer system which provides for the solution of numerical problems via an easily learned language at remote typewriter consoles. The PDP-6 hardware used to implement JOSS consists of 32,000 words of 1.75 $\mu$ sec core memory, a 1 million word, 4 $\mu$ sec drum, a 6 million-word discfile, and various peripheral devices. A special data relocation mode for memory references has been added to facilitate interpretation of JOSS programs. The JOSS consoles, built around a Selectric I/O typewriter, were specially manufactured to RAND specifications. Features include full duplex signalling, line parity checking, a page eject mechanism, and a few buttons and lights to control and report console status. The stand-alone JOSS software consists of the JOSS language interpreter and its arithmetic subroutines, a monitor for user scheduling and resource allocation, and I/O routines for the disc, drum, consoles, and other peripheral devices. JOSS service is currently available to nearly 500 users through 34 consoles - six of which are remote to RAND - operating over both private and Dataphone lines.

## PDP-10 SYSTEM PHILOSOPHY NEW PRODUCT ANNOUNCEMENT

David M. Plumer  
Digital Equipment Corporation  
Maynard, Massachusetts

An analysis of the system design philosophy behind Digital's newly announced PDP-10 Computer series. A discussion of the salient features of hardware and software which combine to make the PDP-10 a true family of totally modular machines. Topics to be considered include: 1) device and memory independent software; 2) batch processing within conversational time sharing; and 3) true upward compatibility within four PDP-10 software systems.

## PDP-8 AS A DATA COLLECTOR IN A TIME-SHARED SYSTEM

Robert P. Abbott  
The Institute of Medical Sciences  
Presbyterian Medical Center  
San Francisco, California

The Institute of Medical Sciences at Presbyterian Medical Center is designing an automated retrieval system for utilization review and hospital admissions. The system will be used to schedule maximum utilization of the basic hospital facilities, (i.e. beds, operating theater, etc.)

The use of computers in this restricted area of hospital utilization and scheduling is not new. The intent of the funding agency, U. S. Public Health Service, is to provide a minimum service at reasonable costs to hospitals which do not, at present, have any automated features.

In the pilot study the methods to be employed will involve remote teletypes throughout a hospital (or hospitals); a PDP-8 serving as a data collector; and telephone lines to a large time-shared computer service. This paper will describe the role of the PDP-8 in this system.

## PDP-6 SYSTEM AT LRL, LIVERMORE

John G. Fletcher  
Lawrence Radiation Laboratory  
Livermore, California

An information-handling system, built around a pair of PDP-6 processors and their 256K memory, is being implemented at the Lawrence Radiation Laboratory, Livermore. These processors are being modified to use segmented and paged addressing. This system will control communication between teletypewriters, display and printing devices, and six computers as large or larger than an IBM 7094; it will maintain files using disc, data cell, and photo-digital storage devices; the latter having a capacity of  $10^{12}$  bits; and it will engage in time-shared program execution, supplementing an existing system operating on CDC 6600's.

## THE BBN ON-LINE PROGRAMMING SYSTEM

Nancy E. Lambert  
Bolt Beranek and Newman, Inc.  
Cambridge, Massachusetts

This paper describes an on-line programming system written for the PDP-1-d used for the Hospital Computer Project at BBN. The system's programs described are the MIDAS assembly program, the EDITOR symbolic text editing program, the DDT debugging program, and the HANDLE file manipulation program.

No attempt is made to justify the use of a time-shared system to perform programming functions, but rather attention is focused on the transition of a set of programs from individual to time-shared use.

## A COMMON MEMORY SYSTEM FOR A TIME-SHARED PDP-6

E. Brazeal  
S. Sharpe  
United Aircraft Research Laboratories  
East Hartford, Connecticut

A multiprocessor capability has been added to United Aircraft Research Laboratory's time-shared PDP-6 computer. A flexible interface was designed to realize this capability. The hardware, "MENTIE," controlled from the I/O bus of the PDP-6, allows the existing PDP-1 computer to share a type 164 memory module with the PDP-6. This common memory system provides the communication potential for various multiprocessing applications.

The paper describes the combined computer facility, the design requirements for the interface, some details of the interface, and certain planned applications for the system.

## ON-LINE REAL-TIME TIME-SHARING OPERATION OF A PDP-7

Lloyd Robinson  
John Meng  
Lawrence Radiation Laboratory  
Berkeley, California

Both hardware and software developments which permit the simultaneous use of a single PDP-7 for the taking and analyzing of data by up to eight experimenters are described. Hardware includes a memory protect system which guarantees the sanctity of switch-selected areas of memory and a unique set of remote consoles. Some programs to be used with the system are still under development, but presently operating routines include ones for storing data on LBM-compatible tape and DECtape, routines for displaying data and operating the remote consoles, and routines for approximating curves with third-order polynomials.

## APPLICATION OF THE PDP-5 TO DATA HANDLING FOR MESON PRODUCED X-RAYS

Robert Lafore  
University of California  
Lawrence Radiation Laboratory  
Berkeley, California

This paper describes the application of a PDP-5 to data handling for meson produced x-rays at the LRL Cyclotron. The program receives data from a 4,000 channel A/D converter, stores it on magnetic tape and provides a scope display (with several ranges) of the data spectrum. In addition, the program provides feedback to the gain and bias settings of the data amplifier; thus insuring minimum drift during the course of the experiment. Various options are provided to the operator by the Teletype keyboard to alter the main part of the program on-line.

## A PDP-5 PROGRAM FOR USE IN NUCLEAR COUNTING

D. R. Thompson  
E. E. Wuschke  
A. Petkau  
Whiteshell Nuclear Research Establishment  
Pinawa, Manitoba, Canada

A program designed to process data from three independent nuclear counting systems will be discussed. Program operations performed on data from two 512 channel gamma spectrometers are print, normalize and subtract background, erase, spectrum strip, integrate, and spectrum data tape read in. A third system, an auto-recycling alpha-beta ionization detector, has routines to initialize for the number of samples and runs, read and store data, calculate counts per minute, and print out data.

A discussion of programming objectives, ease of use, brevity, and revision flexibility, is followed by a description of all programmed operations and their use.

## AN OPERATING SYSTEM FOR THE PDP-8

Professor Jacob L. Meiry  
Massachusetts Institute of Technology  
Cambridge, Massachusetts

The Symbolic Editor and PAL III are two most important programs available to the user of PDP-8. These programs, as written, intercommunicate via punched paper tape and require several passes on the reader. For a facility equipped with DECtape, use of the Editor and PAL III, unmodified, results in a rather poor ratio of I/O versus CP time especially in a facility with a minimum of production runs.

An operating system incorporating modified parts of the DECtape library system, the Symbolic Editor, and PAL III as well as several new service routines are now being tested at the Man-Vehicle Laboratory at MIT. The system enables the operator to edit programs in excess of 4,000 lines, preserve his symbolic writeup on DECtape for future manipulation, and assemble it from tape. With this operating system, dramatic time savings in assembly, of the order of 1/50, have been achieved.

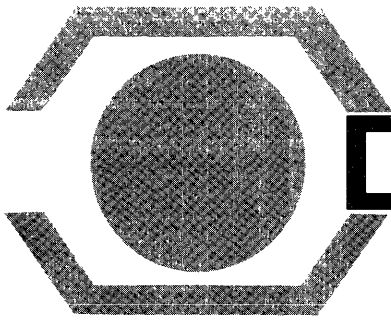

# DECUSCOPE

DIGITAL EQUIPMENT COMPUTER USERS SOCIETY

1966  
Volume 5 No. 9

## DEC ANNOUNCES PDP-10 AT FJCC AND DECUS FALL SYMPOSIUM

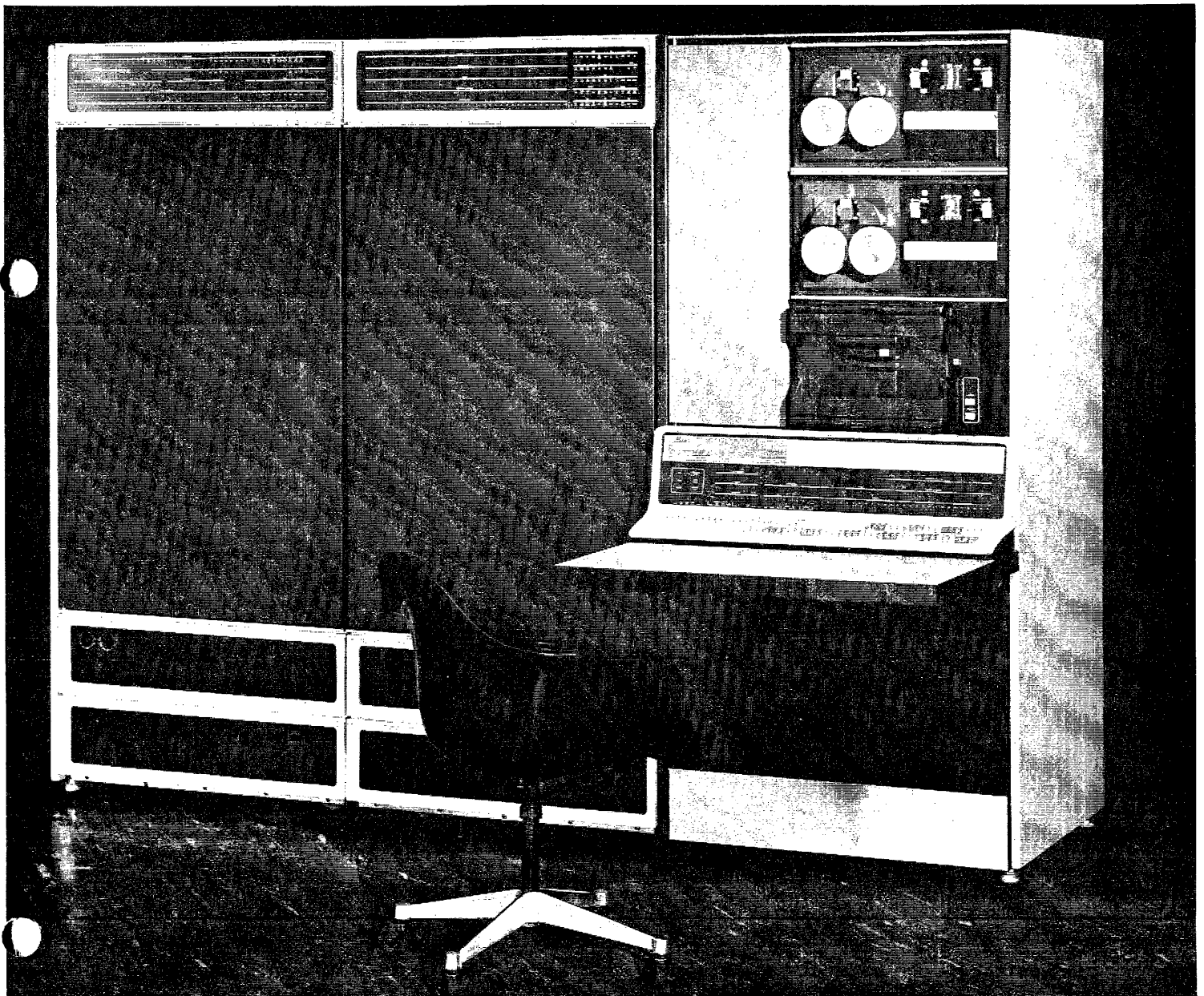

More on PDP-10 on Page 4 and 5



# Table of Contents

New DECUS Officers . . . . . 2  
 DECUS European Committee . . . . . 2  
 Letters . . . . . 3, 4  
 European Proceedings . . . . . 4  
 DEC Software Services Group . . . . . 4  
 DEC Announces PDP-10 . . . . . 4, 5  
 Literature Available . . . . . 5, 6  
 Programs Available from Authors . . . . . 6  
 DECUS Program Reviews . . . . . 6  
 DECUS Library Additions . . . . . 6, 7, 8, 9, 10  
 New DECUS Members . . . . . 10, 11, 12

# New DECUS Officers

January 1967 - December 1968

## Programming Chairman

Richard McQuillin  
Inforonics, Incorporated  
Cambridge, Massachusetts

## Equipment Chairman

Sypko Andreae  
Lawrence Radiation Laboratory  
Berkeley, California

## Publications Chairman

Joseph Lundy  
Inforonics, Incorporated  
Cambridge, Massachusetts

## Note:

Out of 300 ballots sent out, only 80 were returned. This is not a very good showing!! Voting is a fairly simple and painless procedure, and all delegates should return their ballots. DECUS officers play an important part in the organization, and members should be interested in who fills these positions. In the future, we hope to see an improved response in voting.

# DECUS European Committee-1967

## Chairman

Dr. B. E. F. Macefield  
Oxford University, England

## Vice-Chairman

Herrn. H. Karl  
III Physics Institute, Aachen, West Germany

## Accommodation Secretary

Mr. H. Broekhuis  
Hoogovens, Ijmuiden, Holland

## Papers Secretary

Mr. L. P. Goodstein  
Atomic Energy Commission, Denmark

## Proceedings Secretary

Miss E. M. Bowey  
A.E.R.E., Harwell, England

DECUSCOPE is published monthly for Digital Equipment Computer Users Society (DECUS).

Material for publication should be sent to: Angela J. Cossette, DECUS, Maynard, Massachusetts 01754. Telephone: AC 617 897-8821, TWX 710 347-0212

Publications Chairman: Joseph Lundy, Inforonics, Inc.

Circulation: 1,885 copies per month

DECUS acknowledges the assistance of Digital's Technical Publications Department in the preparation of this newsletter.

# " LETTERS "

"Dear DECUS Member:

The first meeting in Europe of DECUS was very enjoyable and served to focus attention on the difficulties experienced by users in Europe. With the latter in mind you will find enclosed copies of letters sent to the Presidents of DEC and DECUS.

We would set out the following modus operandi for DECUS Europe:

(1) To attempt to improve contact between the Company and Users and between various users and to help in arranging any detailed collaboration that may be required.

(2) To recommend that faults in software or hardware should be notified in writing to the local DEC office and to Maynard direct. If any difficulty is experienced then the Vice Chairman or Chairman should be notified.

(3) To communicate to the Vice Chairman or Chairman any specific requirement of possible general interest. The former will then circulate the requirement among members to get a consensus.

It would be helpful to all members receiving these proceedings should within two weeks send a short one page description of the application of the DEC machine in their organization to DEC (UK); these will then be circulated.

The Chair hopes that committee members will encourage collaboration in their own areas.

The next meeting has been scheduled for two days during the period 24th-28th October, 1966, in Aachen, West Germany. Lists of the European committee members and of the attendance at the Seminar are enclosed. The proceedings will be forwarded as soon as they are published.

Yours faithfully,

DECUS COMMITTEE-Europe  
H. Karl Vice Chairman  
B. Macefield Chairman"

"The President,  
Digital Equipment Corporation,  
Maynard, Massachusetts

Dear Sir,

As you will perhaps be aware the European branch of DECUS has just held its first meeting in London. The European DECUS Committee would like to thank the company for its support and efforts in arranging this initial meeting.

It proved a very fruitful meeting in many respects, the most important of which was the focussing of attention on users difficulties and complaints.

The committee were requested to communicate the following deficiencies and recommendations to Maynard with all speed.

(1) It is recommended that in future as soon as a new machine is ordered the purchaser should be sent a complete listing, tapes both binary and symbolic of all programmes that at present would be released with the machine. It is most important that this data be sent before the machine is delivered. Hardware drawings, even if only training drawings, should be sent at the same time. Statements by DEC representatives that the above is the present policy of the company is not substantiated by the users who have had to wait many months for such information.

(2) It is recommended that if any errors in programmes issued with the machines are notified to DEC the informant should be notified of receipt and if substantiated all users should be notified immediately. The same of course is true for hardware problems.

(3) In view of the numbers of DEC machines at present in Europe and the numbers shortly being installed it is hoped that the DEC representatives in Europe should hold a complete stock of maintenance modules together with specialised equipment like display CRT, light pens, plotter replacements etc. The capital investment for this must be a small price to pay for the good will engendered.

(4) It is recommended that all users be kept very well informed of future developments.

The atmosphere of the meeting indicated that these were very real worries and not just pious hopes.

The next DECUS meeting in Europe has been scheduled in Aachen for two days during the period 24th-28th October, 1966. European members would appreciate a soft and hardware expert from Maynard to be present to answer questions during this period.

Yours faithfully,

DECUS COMMITTEE-Europe  
K. J. Karl, Vice Chairman  
B. E. Macefield, Chairman"

"Dr. B. E. Macefield  
DECUS Committee Europe  
Nuclear Physics Department  
University of Oxford  
21 Banbury Road  
Oxford, England

Dear Dr. Macefield:

I appreciate your taking the time and trouble to draw together the suggestions of the European DECUS group and sending them to us. An answer to your letter was delayed so that positive action could be reported on each of the group's requests.

An internal system had been set up to transmit a complete set of program writeups as soon as each order is received.

Your letter brought to our attention that this was not always being done and corrective action has been taken. Since program tapes are not useful until the equipment is delivered, these are sent with the computer shipment.

The idea of sending a set of training drawings as soon as an order is received is excellent. We are taking the suggestion and expect it to be fully implemented by July 1, 1966.

Errors in programs continue to plague us both. We hope to solve the problem of distributing correction information through a periodic newsletter (perhaps the DECUSCOPE). Distribution of correction tapes would then be on a request basis. Hardware errors are corrected immediately, without charge, if required to bring the system up to specification. The Field Service personnel always have information on the current non-mandatory engineering changes.

Stocking of spare parts for our computers in Europe is now in full swing. In addition to our present field office spares, we will shortly be opening a bonded warehouse to stock items that are more expensive than modules. It is our intent to have sufficient spares to service 99 calls out of 100 without recourse to the U. S. supplies.

Finally, we are indeed trying to keep all users fully informed. Information on new products will reach present users before the general public, and we are pleased to give them advanced data.

I hope this answers all your requests and that we will hear from you again when additional suggestions arise.

Sincerely,

Kenneth H. Olsen  
President"

## DECUS European Seminar Proceedings

The Proceedings of the European Seminar held in London on April 27 and 28, 1966, are now available from the DECUS office, Maynard, Massachusetts. European members who have not already received a copy, should direct their request to Ray Jones, Digital Equipment Corporation (U.K.) Ltd., 3 Arkwright Street, Reading, Berkshire, England. U.S. members should direct requests to Angela Cossette, DECUS office in Maynard.

Due to the limited number of these proceedings, we must deviate from the normal procedure of sending proceedings automatically to all delegates. Copies will be sent only on a request basis. Abstracts of the papers were published, as an insert in DECUSCOPE, Volume 5, Issue No. 6.

## DEC Software Services Group

DEC has recently organized a Software Services Group. The group, headed by Harvey Shepherd, will handle all DEC Program Library and Maindec material. The Software Services Group has the following supervisory breakdown:

Quality Control and	
Systems Maintenance	Mrs. Evelyn Dow
Computer Library	Mrs. Bonnie Karsman
Library Support	Mrs. Marie Ellison

The Quality Control Group will perform acceptance testing on all new programs going into the DEC Library. This group is also the one to contact if you have any corrections or additional programs you would like to see in the Library.

Systems Maintenance will take on the job of reviewing and re-editing the Program Library as it now stands, as well as taking over maintenance of future programs once they are accepted by Quality Control.

The Program Library Group will handle both the shipping of advanced software and the filling of supplementary requests.

The Library Support Group is an internal operation that prepares tapes, listings, and assemblies for programming and the test floor.

One of the initial goals of the Software Services Group is to establish an updated list of customers including direct software contacts. The Sales Group is providing considerable help in developing this centralized listing, and we expect that each DEC customer will receive a letter requesting verification of name and address.

## DEC ANNOUNCES PDP-10

The PDP-10, a new, expandable computer system available in five configurations and offering optimum power and versatility in the medium price range, was introduced by Digital Equipment Corporation at the opening session of the 1966 Fall Joint Computer Conference in San Francisco, and at the DECUS Fall Symposium, Lawrence Radiation Laboratory, Berkeley, California.

The PDP-10 is designed for on-line and real-time scientific, engineering and process control applications with prices starting at \$110,000. The PDP-10 features a 1 microsecond cycle time, a 2.1 microsecond add time, I/O bus transfer rates up to 7,200,000 bits per second and a modular, proven software package that expands to take full advantage of all hardware configurations. Memory can be expanded in 8,192 word increments to the maximum directly addressable 262,144 words.

### The Five Configurations

The basic configuration PDP-10/10 includes an extremely powerful programmed processor with 15 index registers,

16 accumulators and 8,192 words of 36-bit core memory, a 300-character-per-second paper tape reader, a 50-character-per-second paper tape punch, a console teleprinter, and a two-level priority interrupt subsystem. Source and object programs reside on paper tape.

PDP-10/20 adds two DECTapes, Digital's unique fixed-address magnetic tape system which allows compact file structured storage. A single tape may contain multiple files of various types; any single file may be deleted, changed, or expanded without effecting other files on the tape. Source and object programs reside on DECTape providing maximum flexibility and programmer convenience.

Another configuration, the PDP-10/30, offers the user still more versatility. It includes, along with the standard processor features, 16,384 words of memory, and additional I/O devices. This system is designed to facilitate stand-alone computing capabilities incorporating specially designed customer hardware and software.

### Time Sharing

The fourth configuration, PDP-10/40, incorporates 16,383 words of memory, extended order code and the memory protection and relocation feature. The PDP-10/40 multiprogramming/time-sharing software has been in successful operation for the last two years. It includes facilities for real-time and batch processing.

The final configuration, the PDP-10/50, permits swapping between 32,768 words or more of core memory and fast access disk file via the multiplexer/selector channel. This system includes complete multiprogramming time-sharing software.

### Software

PDP-10 utilizes five distinct levels of software keyed to a variety of processor and/or core memory options. All software systems have been designed to expand PDP-10 performance easily to include any standard option without requiring costly special reprogramming.

All software systems assure upward compatibility from the standard 8,192 words of memory through the multiprogramming and swapping systems at both the symbolic and relocatable binary level. (For example, a FORTRAN IV program compiled on the basic PDP-10 system can be link-loaded and executed under time sharing without the need to recompile.)

The software package includes real-time FORTRAN IV, a control monitor, a MACRO assembler, a context editor, a symbolic debugging program, an I/O controller, a peripheral interchange program, a desk calculator, and library programs. All attainable via the DEC conversational mode.

In addition to software compatibility throughout all configurations, the system's programs are device independent. They obtain their I/O services through calls to the same I/O package used by the FORTRAN object programs and accessible to any user's program. Also, designed into

each of the software systems is the ability to incorporate service routines for real-time applications and/or non-standard I/O devices.

The PDP-10 system is expected to find wide acceptance in applications such as physics and biomedical research, as a departmental computation facility, in simulation and aerospace, process control, chemical instrumentation, display processing, and as a science teaching aid. First deliveries of the system are scheduled for September, 1967.

The PDP-10 marks the third new computer system to be introduced by DEC in the last five months. Digital recently introduced the PDP-8/S, the first full-scale, general-purpose core memory digital computer selling for under \$10,000, and the PDP-9, the largest general-purpose system in the low-cost field.

## LITERATURE AVAILABLE

### FROM DEC LIBRARY - BONNIE KORSMAN

347 Subroutine Interface Instruction Test, Digital-7-66-M, is a test of the 347 Subroutine Interface Option for the 340 Display with a PDP-7 (8K).

PDP 4/7 57A Test Routines, Digital-7-76-M, describes the routines which form a complete performance check of the 57A.

PDP-7 I/O Trap Test, Digital-7-84-M-HRI, describes the routine which exercises the I/O trap on the PDP-7. When the I/O trap is enabled, three types of instructions are trapped, namely all IOT instructions, all XCT instructions, and the HLT portion of the operate class instruction. The test consists of several sequences of instructions designed to exercise the I/O trap. Should the trap fail, each sequence contains a programmed halt which identifies where the trap failure occurred.

FORTMAN Manual Change Notice, Digital-8-2-S, updates the PDP-8 FORTRAN Manual.

TC01 DECTape Subroutines, Digital-8-31-U, allow the user to read, write, and search using the TC01 Tape System. Provision is made for transfers to and from extended memories.

Programmed Buffered Display 338 Programming Manual, DEC-08-G61A-D, describes the 338 Display as it operates with a PDP-8. The manual consists mainly of programming information and includes specific programming examples.

LINC-8 Library System, DEC-L8-SL1A-D, describes the LINCtape-8 Library System. This system is an adaption of the PDP-8 Library System. Some of the conventions with respect to last page storage have been changed. Its operation, however, is very similar to the PDP-8 Library System.

LINC-8 Library System, DEC-L8-SL1A-LA, is the listing of the LINC-8 Library System.

Extended Memory Control - Part 1, Maindec 820-1, (Revised 9/8/66), describes the program which exercises and tests the control section of Extended Memory Type 183 on a PDP-8. It tests instructions CDF, CIF, RDF, RIF, RMF, and RIB for proper operation.

Type 30 N, G, Display Exerciser, Maindec 843, describes the program which tests the operation of the deflection circuits, decoder network, coordinate buffer, and phosphor coating of the CRT.

PDP-8 A/D Converter Test, Maindec 845, for the T38E/T39E and T89 Converters is a set of routines to aid maintenance personnel in debugging hardware. The test is also a confidence check for data flags, interrupts, monotonicity, steady state accuracy, multiplexer selection, and incrementation ability of the multiplexer.

FROM GERTRUDE LOYND, DEC

PDP-9 User Handbook (Preliminary, F-95P), describes the PDP-9 which is a general-purpose, solid-state, digital computer designed for high-speed data handling in the scientific laboratory, the computing center, or the real-time process control system. Included in the handbook are programmer and operator guides.

## Programs Available From Authors

Title: Morse Code Sender for PDP-5/8

Author: Jack Harvey, Communication Systems, Inc.  
Paramus, New Jersey

This subroutine is entered with an ASCII character (trimmed or untrimmed) in the AC.

A square wave tone of the international Morse code for the character is sent to any appropriate output device such as a digital to analog converter, binary channel, or scope display. The program is easily altered to suit the particular output channel available. An ordinary audio amplifier and speaker on the channel make the tone audible. Three registers on page zero control tone pitch, code speed and character spacing.

Documentation available from author:

1. Binary tape, routine uses 400-577
2. Symbolic tape with relative addresses, no comments
3. Photocopies of the author's notes on the listing of (2).

# DECUS PROGRAM LIBRARY

## DECUS LIBRARY PROGRAM REVIEW

Several review sheets on programs have been received at the DECUS office. However, only program reviews that suggest modifications will be published in DECUSCOPE.

PROGRAM REVIEWED:

DECUS No. 5-36, Octal Memory Revised

REVIEWED BY:

Gary H. Sanders, Columbia Radiation Labs.,  
New York

COMMENTS:

Presently, starting address (7600) causes Binary Loader to be destroyed. Suggest lowering the starting address.

### Author's Comment

"I originally mailed DECUS copies assembled in locations \*200-300 as well as \*7600-7700, exactly as the original octal tape dump was assembled. The purpose of putting the subroutine in one page was to insure its mobility."

Paul D. Hammond  
Woods Hole Oceanographic  
Institution

PROGRAM REVIEWED:

DECUS No. 5/8-9, Analysis of Variance

REVIEWED BY:

F. W. Foess, University of Michigan, Brain  
Research Laboratory, Ann Arbor, Michigan

COMMENTS:

We feel that the following modifications make the program easier to use:

1. Teletype returns LF after CR has been typed.
2. Modification of program to print results as decimal instead of "E" format makes output easier to handle.

## PDP-1 PROGRAM LIBRARY ADDITIONS

DECUS No. 89 and 89a

Title: Cube Display and Matchbox Display

Author: T. Hart, Bolt Beranek and Newman, Inc.,  
Cambridge, Massachusetts

Demonstration programs displaying a cube or matchbox for use with the PDP-1 and Type 30 Display.

## PDP-5/8 PROGRAM LIBRARY ADDITIONS

### DECUS No. 5/8-18(a) Revised

Title: Bin Tape Disassembly Program for PDP-5/8 Computer

Disassembles a PDP-5/8 program which is on tape in BIN format. The program prints the margin setting, address, octal contents, and mnemonic interpretation (PAL) of the octal contents. This program has been modified to operate correctly when the ASR-33 reader is used. A feature has been added so that programs which have been coded using the Floating Point Package may also be disassembled.

### DECUS No. 5/8-45

Title: PDP 5/8 Remote & Time-Shared System

Author: James Miller, Dow Badische Chemical Company, Freeport, Texas

There are two modes of remote operation: "time-sharing" and "remote mode."

The spool of DECTape on transport No. 1 can contain 40 programs which fill the entire memory (such as FORTRAN programs). Each 26 of these are called by any of eight remote stations during remote mode operation. Once a station calls a remote program only that station can access the computer until the user at that station executes a release (bell character).

The spool of DECTape on transport No. 2 contains time-shared programs. The time-shared system is set in motion by calling the time-sharing package program on transport No. 1. Once called the system is usable by five teleprinters at the same time. (The number of participating stations can be expanded by additional hardware.) Each teleprinter has a dedicated area of memory four "pages" long; one page is used to reference the common math, text and DECTape subroutines. The remaining three pages are used for the program specific to an individual teleprinter. Long programs are constructed by simply chaining together several three-page programs by calling subsequent portions from DECTape under program control or from the keyboard. Three pages of programming are quite powerful due to the availability of strong supporting common subroutines.

In either remote mode or time sharing, seldom used programs can be kept on paper tape and read in remotely when needed.

With remote mode many DEC programs are usable; such as the FORTRAN compiler, FORTRAN OTS, DEC Calculator, etc.

A calculator routine is available with the time-shared system, also a message sending routine and a remote binary loader.

### How The Time Is Shared

There are two subroutines which work together to share the time and they use registers on page zero to find out what to do.

### Executive Routine:

This routine continually searches to see if a keyboard entry or timeout character is seeking recognition and checks all time-shared stations in order. (i.e. If location 51 contains a 1, the routine then knows someone has typed a character at station 1 and the routine looks at area 131 to determine where to go to service it. If 51 contains zero, no character has been entered. Area 52 containing a 1 means teleprinter 2 is trying to input, etc.)

Characters on input or output are temporarily stored in a "list" which is different for different stations. These "lists" are filled or typed out of one character at a time and between characters all other stations are checked or serviced by the executive routine. These "lists" are handled by the time-sharing subroutines as the actual input or output when delimited.

### Interrupt Routine:

Anytime a flag is set (meaning a station is trying to input or output), the interrupt routine is automatically entered to set up registers on page zero which indicate to the executive routine that this station should be serviced on the next scanning cycle. The station is not immediately serviced but must wait its turn some  $\mu$ secs later when the executive routine recognizes it.

The total effect is simultaneous execution of entirely different programs by different users with no apparent delay or interference.

### Necessary Equipment

PDP-5 (or PDP-8) with 4K memory  
552 DECTape control with 555 Dual Tape Transports  
630 data communications system with five channels complete  
5 remote teleprinters  
5 "reader-stop" cards for remote teleprinters  
5 "clear reader flag only" modules

Individual cable to each remote station with 6 conductors

### Desirable Additional Equipment

3 remote teleprinters with "reader-stop" card to function in remote mode (but not time sharing). These can also be used as message receiving stations.  
Teleprinter equipped for remote operation but located at the console to be used for debugging time shared and remote programs.  
Spare spool of DECTape for each active spool.

### DECUS No. 5/8-46

Title: PDP-5/8 Utility Programs

Author: Edward Della Torre, American-Standard, New Brunswick, New Jersey

Utility Programs in the present form consist of four programs (listed below), each of which may be selected via the teletypewriter. When the program is started, either

by a self-starting binary loader or by manually starting the computer in address 200<sub>(8)</sub>, it is in its executive mode. In this mode, it will respond only to five keys and perform the following functions.

- B - go to BIN to QK Converter Program
- E - go to Editor Program
- L - type a section of leader and stay in executive
- P - go to Page Format Program
- Q- go to QK to BIN Converter Program

When any program is terminated, the computer will return to executive and wait for the next instruction. In all programs if bit 11 is set to 1, the output will be on the high-speed punch; if zero, output will be on the teletypewriter punch. In low-speed punch mode, if the high-speed punch is turned on, it will punch there too but at teletypewriter speed. Bit 10 set equal to 1 causes a halt at the end of the page of programs using the page format mode. The individual programs are:

Editor: This program permits editing a tape under typewriter control by copying it from the high-speed reader to either punch.

Page Format: Tape to be formatted is read-in via the high-speed reader, copied and after a page-size section has been typed, the page is numbered and three dashes are typed to mark the end of the page. The program has the facility to allow the computer to halt to permit tearing of the page and resume copying.

BIN to QK Converter: This is a binary tape disassembler. The octal contents are typed in the same format as the first two columns of PAL Pass III. This is useful for identifying an unknown tape or for editing a binary tape using the Editor program.

QK to BIN Converter: This program will punch a binary or RIM tape from an ASCII control tape via the high-speed reader.

#### DECUS No. 8-47

Title: ALBIN, A PDP-8 Loader for Relocatable Binary Programs

Authors: J. L. Visschers, P. U. ten Kate and M. A. A. Sonnemans, Instituut voor Kernfysisch Onderzoek (IKO), Amsterdam, Netherlands

ALBIN is a simple method for constructing relocatable binary formatted programs, using the PAL III Assembler. Allocation of these programs can be varied in units of one memory page (128<sub>10</sub> registers). When loading an ALBIN program, the actual absolute addresses of indicated program elements (e.g. the keypoints of subroutines) are noted down in fixed program-specified location on page zero. In order to make a DEC symbolic program suitable for translation into its relocatable binary equivalent, minor changes are required, which, however, do not influence the length of the program. Due to its similarity to the standard DEC BIN loader, the ALBIN loader is also

able to read-in normal DEC Binary tapes. ALBIN requires 122<sub>10</sub> locations, RIM loader included. Piling-up in core memory of ALBIN programs stored on conventional or DECtape can be achieved using the same method with some modifications.

#### DECUS No. 5/8-48

Title: Modified Binary Loader MK IV

Author: R. Ward, American-Standard Research Division, New Brunswick, New Jersey

The Mark IV loader was developed to accomplish four objectives:

1. Incorporate the self-starting format described in DECUS 5/8-27, ERC Boot.
2. Select the reader in use, automatically, without switch register settings.
3. Enable a newly-prepared binary tape to be checked prior to loading by calculating the checksum.
4. Reduce the storage requirements for the loader so that a special program would fit on the last page of memory with it.

The desired self-starting format was incorporated with the addition that the loader will branch to the starting address automatically if there is no checksum error.

Automatic selection of which reader is being used was accomplished by the READ routine (7652-7665) which interrogates both the high and low-speed readers. Confusion will result if tapes are placed in both readers and if they are both turned on.

A switch register option allows tapes to be read but not loaded so that the checksum and tape can be verified. The HALT instruction has been placed so that a new option can be selected without reloading the starting address.

Finally, storage was reduced to 83<sub>(10)</sub> locations. All temporary locations were placed at the beginning of the program in memory. Thus, 7600-7640 are available for other uses. The area 7756-7776 is normally occupied by the RIM loader.

#### PDP-6 PROGRAM LIBRARY ADDITIONS

##### DECUS No. 6-1

Title: ALPHAS

Author: Richard Gruen, Digital Equipment Corporation, Palo Alto, California

Classification: Character Set

Minimum Hardware Configuration:  
Time-Shared PDP-6; Type 340 Display

Source Language: Macro-6

Available: ASCII Source on DECTape - Listing

Contains a set of the most used ASCII characters (letters, numbers, and a few other characters) for use with the 340 Display. Also included is a small driver program illustrating use of the display in time-sharing.

#### DECUS No. 6-2

Title: LPFOL

Author: Richard Gruen, Digital Equipment Corporation,  
Palo Alto, California

Classification: Utility Program

Minimum Hardware Configuration: Time-Shared PDP-6; Type 340 Display; ECO

Source Language: Macro-6

Available: ASCII Source on DECTape - Listing

Displays a square at the last point seen by the light pen. Follows the light pen as the pen moves around the screen.

#### DECUS No. 6-3

Title: PUNCH

Author: Richard Gruen, Digital Equipment Corporation,  
Palo Alto, California

Classification: Utility Routine

Minimum Hardware Configuration: Operates in PDP-6  
Time-Sharing System; uses Paper Tape Punch

Source Language: Macro-6

Storage Requirement: 1K

Available: ASCII Source on DECTape - Listing

The program accepts characters from the Teletype and punches them (in hand-readable format) onto paper tape. It can easily be modified for use as a titling subroutine.

#### DECUS No. 6-4

Title: NUMBER

Author: Richard Gruen, Digital Equipment Corporation  
Palo Alto, California

Classification: Demonstration Routine

Minimum Hardware Configuration: Operates in PDP-6  
Time-Sharing System; uses Line Printer

Other Programs Needed: FORTRAN Library

Source Language: FORTRAN IV (Number F4) or FORTRAN  
II (Number F2)

Storage Requirement: 3K including Library

Execution Time: Approximately 1/2 minute/number

Available: ASCII Source on DECTape - Listing

NUMBER converts 7 digit telephone numbers into mnemonics. It prints all mnemonics for a given phone number on about four pages of line printer paper.

#### DECUS No. 6-5

Title: TIMEF4

Author: Richard Gruen, Digital Equipment Corporation,  
Palo Alto, California

Classification: Timing Program

Minimum Hardware Configuration: Operates under the  
PDP-6 Time-Sharing System

Other Programs Needed: FORTRAN IV Library

Source Language: Macro-6

Storage Requirement: Uses 1K core plus size of FORTRAN  
IV Library

Execution Time: 1/2 - 1 1/2 hours

Available: ASCII Source on DECTape - Listing

TIMEF4 calls each of the FORTRAN IV Library routines 20,000 times and publishes the average time per call. It uses randomly generated numbers as input. This program was used to calculate the timings shown in the FORTRAN IV Library writeups.

### PDP-7 PROGRAM LIBRARY ADDITIONS

#### DECUS No. 7-21

Title: Reaction Kinematics

Author: Philip Bevington, Stanford University, Stanford  
California

Reaction Kinematics is a FORTRAN program for use with nuclear reactions to tabulate the transformations of energies, angles, and cross sections non-relativistically between the laboratory and the center-of-mass system. It provides communication between an operator at the console of a computer and the subroutine KINEMATICS (DECUS No. 7-5) to specify the input parameters and output format.

#### DECUS No. 7-22

Title: LEGFIT

Author: Dale Heikkinen, Stanford University, Stanford,  
California

LEGFIT is a FORTRAN program which performs a least-



squares fit to data with a Legendre polynomial expansion of the form

$$Y(\theta_i) = \sum_{L=0}^N A_L P_L(\cos \theta_i).$$

The expansion can contain both even and odd terms or even terms alone, depending on the user's option. The program uses the subroutine MATINV for matrix inversion. The version of LEGFIT described here is written in PDP-4/7 FORTRAN (three-word mode).

#### DECUS No. 7-23

Title: OUTFLT

Author: Philip Bevington, Stanford University, Stanford, California

OUTFLT is a FORTRAN subroutine for the PDP-4/7 to punch in an integer mode compatible with INFLT ND 180 (DECUS No. 7-7) arrays of numerical data in two-word floating-point mode. The output format is ASCII code with six digits per word, eight words per line, spaces between words on a line but not preceding the first word, and a carriage return/line feed pair at the end of each line. This is the same code as that utilized by Nuclear Data multichannel pulse-height analyzers with teletypewriter outputs.

Numbers will be rounded off to the nearest integer before punching. Spaces will be substituted for insignificant zeros. A short leader of blank tape will be punched before and after each array of data punched.

Since a maximum of six digits is punched per number, numbers larger than 999,999 or smaller than 1 will be considered to be  $\emptyset$ . Minus signs will be punched for negative numbers between -1 and -99,999; numbers between -100,000 and -999,999 will be truncated.

#### DECUS No. 7-24

Title: ENLOSS

Author: Dale Heikkinen, Stanford University, Stanford, California

ENLOSS is a kinematics program for nuclear reactions with provision for a determination of the energy loss of the outgoing light particle due to passage through foils.

This program corrects for energy loss using range data. The ranges in  $\text{mg}/\text{cm}^2$  of Al for protons, deuterons, tritons,  $\text{He}^3$ , and  $\text{He}^4$  are contained in the function R(I, J). The function R(I, J) used by ENLOSS is simply a table of range data indexed according to energy and particle type. These data were obtained for the most part from W. Whaling--Handbuch der Physik. ENLOSS is written entirely in FORTRAN.

# NEW DECUS MEMBERS

#### PDP-4 DELEGATE

James Baldrige  
University of California  
Lawrence Radiation Laboratory  
Berkeley, California

#### PDP-5 DELEGATES

Donald O. Newton  
San Francisco Bay Naval Shipyard  
Vallejo, California

C. B. Weick  
Ottawa Technical High School  
Ottawa, Ontario, Canada

#### PDP-7 DELEGATES

Dr. Antony Robin Atherton  
Cambridge University  
Cambridge, England

Norman J. Beshears  
Jet Propulsion Laboratories  
Pasadena, California

Robert E. Enos  
Northern Electric Company Ltd.  
Montreal, Canada

B. T. Fox  
Sandia Corporation  
Albuquerque, New Mexico

Harlan W. Lefeure  
University of Oregon  
Eugene, Oregon

Paul G. Sandberg  
Foxboro Company  
Foxboro, Massachusetts

Dr. H. Schneider  
Institut für Hochenergiephysik  
der Universität Heidelberg  
Überlestr. 2, Germany

David J. Waks  
Applied Data Research, Inc.  
Princeton, New Jersey

#### PDP-8 DELEGATES

Dr. D. D. Aueenkamp  
Oregon State University  
Corvallis, Oregon

Robert S. Babyar  
Hines V. A. Hospital  
Hines, Illinois

PDP-8 DELEGATES (continued)

W. Wayne Black  
Idaho Nuclear Corporation  
Idaho Falls, Idaho

C. Bouthier  
C. F. Thomas Houston  
Gennevilliers (Seine), France

William S. Cooke  
Applied Data Research, Inc.  
Princeton, New Jersey

Professor E.R.F.W. Crossman  
University of California  
Berkeley, California

Stanley D. Davis  
Rome Air Development Center  
Rome, New York

James L. Downs  
Badger Meter Manufacturing Co.  
Milwaukee, Wisconsin

B. A. Eisenstein  
Drexel Institute of Technology  
Philadelphia, Pennsylvania

Peter Jackson Ellis  
Australian Atomic Energy Commission  
N.S. Wales, Australia

Frederick C. Fensch  
Mental Health Research Institute  
Ann Arbor, Michigan

F. W. Foess  
University of Michigan  
Ann Arbor, Michigan

Theo Fensch  
Hewlett-Packard Company  
Palo Alto, California

Saul Goldstone  
Airborne Instruments Laboratory  
Deer Park, New York

Larry R. Gordon  
University of North Carolina  
Chapel Hill, North Carolina

Professor R. M. Grainger  
University of Toronto  
Toronto, Canada

R. A. Gruenewald  
Dr. Neher Laboratory  
Leidschendam, The Netherlands

Mrs. Sara Helmick  
Los Alamos Scientific Laboratory  
Los Alamos, New Mexico

William C. Hrasky  
Pomfret School  
Pomfret, Connecticut

PDP-8 DELEGATES (continued)

Dr. T. Lang  
Culham Laboratory  
U.K. Atomic Energy Authority  
Berkshire, England

Harold Neer  
Phillips Petroleum Company  
Bartlesville, Oklahoma

Jay C. Nelson  
Union Carbide Corporation  
South Charleston, West Virginia

Anthony Palmieri  
Alphanumeric Incorporated  
Hicksville, Long Island

J. J. H. Park  
National Research Council  
Ottawa, Ontario, Canada

Daniel G. Parrish  
Veterans Administration Hospital  
Seattle, Washington

August E. Sapega  
Trinity College  
Hartford, Connecticut

Kenneth L. Slawson  
Wales Strippit  
Akron, New York

R. J. Sparks  
Institute of Nuclear Sciences  
Lower Hutt, New Zealand

Mervyn Sullivan  
Northern Electric Company, Ltd.  
Ottawa, Ontario, Canada

Hiroo Washimi  
Dowa Mining Company, Ltd.  
Akita-ken, Japan

George A. Wertheim  
Stanford University  
Palo Alto, California

Dr. William S. Yamamoto  
University of Pennsylvania  
Philadelphia, Pennsylvania

LINC DELEGATES

Dr. William R. Goff  
Veterans Administration Hospital  
West Haven, Connecticut

Dr. Clinton N. Latimer  
American Cyanamid Company  
Pearl River, New York

LINC-8 DELEGATES

Robert C. Bilger  
Eye and Ear Hospital of Pittsburgh  
Pittsburgh, Pennsylvania

Dr. Frederick L. Hiltz  
Bio-Tronics Research, Inc.  
New London, New Hampshire

Hans Reiter  
Physiologisches Inst. der IU Berlin  
Arnimallee 22, Germany

340 DISPLAY DELEGATE

Thomas G. Evans  
Air Force Cambridge Research Labs.  
Bedford, Massachusetts

INDIVIDUAL MEMBERS

Joseph Barbarino  
New York University  
New York, New York

Murray Baron  
Stanford Research Institute  
Menlo Park, California

Blaine Belecki  
Northern Electric  
Montreal, Quebec, Canada

Allan R. Benyowitz  
Associated Aero Science Labs., Inc.  
Pasadena, California

Linda J. Bernhardt  
McLean Hospital  
Belmont, Massachusetts

Phillip J. Best  
University of Michigan  
Ann Arbor, Michigan

Reginald G. Bickford  
Mayo Clinic  
Rochester, Minnesota

Mark S. Bilk  
University of Pennsylvania  
Philadelphia, Pennsylvania

ir. E. H. Boiten  
Hoogovens N.V.  
IJmuiden, Holland

I. G. Bradbury  
University College of London  
London, England

H. J. Bridges  
University of British Columbia  
Vancouver, British Columbia

John A. Burdeshaw  
University of Alabama Medical Ctr.  
Birmingham, Alabama

INDIVIDUAL MEMBERS (continued)

Quentin Chin  
Stromberg-Carlson Corporation  
San Diego, California

Robert C. Cliff  
University of California  
Berkeley, California

Owen Chamberlain  
Lawrence Radiation Laboratory  
Berkeley, California

Robert M. Companick  
Western Electric  
Trenton, New Jersey

Donald V. Conroy  
University of Alabama Medical Ctr.  
Birmingham, Alabama

Harold W. DeBray  
United States Steel  
Homestead, Pennsylvania

Th. Den Dunnen  
Dr. Neher Laboratory  
Leidschendam, The Netherlands

Clarence G. Donahoe  
San Francisco Bay Naval Shipyard  
Vallejo, California

John Drumheller  
Adams Associates  
Bedford, Massachusetts

Dr. E. E. Eddleman, Jr.  
Veterans Administration Hospital  
Birmingham, Alabama

Donald R. Fanshier  
Lawrence Radiation Laboratory  
University of California  
Berkeley, California

Robert J. Fitzhugh  
University of California  
Berkeley, California

Jack W. Frazer  
Lawrence Radiation Laboratory  
Livermore, California

John Stephen Gandee  
Standard Telephones and Cables Ltd.  
Barnet, Herts, England

Robert S. Haas  
University of Rhode Island  
Kingston, Rhode Island

Kent Larry Harding  
Union Carbide Chemical Company  
Torrance, California

Bill G. Harris  
University of North Carolina  
Chapel Hill, North Carolina

INDIVIDUAL MEMBERS (continued)

M. W. Hart  
University of Minnesota  
Minneapolis, Minnesota

Timothy P. Hart  
Air Force Cambridge Research Lab.  
Hanscom Field  
Bedford, Massachusetts

Harold E. Hosticka  
University of Pittsburgh  
Pittsburgh, Pennsylvania

Lyle V. Jones  
University of North Carolina  
Chapel Hill, North Carolina

Jovan Jovanovich  
University of Manitoba  
Winnipeg 19, Manitoba, Canada

Robert M. Keller  
Washington University  
Lemay, Missouri

George V. Kempston  
Standard Telephones and Cables Ltd.  
Barnet, Herts, England

Isadore M. Klahr  
University of Pittsburgh  
Pittsburgh, Pennsylvania

Stanley Klezmer  
Lawrence Radiation Laboratory  
Berkeley, California

Professor Leon J. Lidofsky  
Columbia University  
Brooklyn, New York

Dr. John Francis Lubin  
University of Pennsylvania  
Philadelphia, Pennsylvania

George P. Lucas  
United Aircraft Research Labs.  
East Hartford, Connecticut

B. A. Mair  
Plessey Company Ltd.  
Hampshire, England

E. F. Matthews  
Broken Hill Pty Ltd.  
Shortland 2N, N.S.W. Australia

G. J. McCallum  
Institute of Nuclear Sciences  
Lower Hutt, New Zealand

Thomas McHugh  
United Aircraft Corporation  
East Hartford, Connecticut

John Metzger  
Princeton-Pennsylvania Accelerator  
Princeton, New Jersey

INDIVIDUAL MEMBERS (continued)

G. A. Michael  
Lawrence Radiation Laboratory  
Livermore, California

S. Michaelson  
University of Edinburgh  
Edinburgh, Scotland

Arthur R. Miller  
Woods Hole Oceanographic Institution  
Woods Hole, Massachusetts

Dr. David C. Miller  
Massachusetts Institution of Technology  
Cambridge, Massachusetts

J. C. D. Milton  
Chalk River Nuclear Laboratories  
Chalk River, Ontario, Canada

Marvin Minslry  
Project MAC, M.I.T.  
Cambridge, Massachusetts

William D. Nelson  
Applied Logic Corporation  
Princeton, New Jersey

Richard J. Niemczyk  
United Aircraft Research Laboratories  
East Hartford, Connecticut

Kjell Nordin  
Arenco Electronics  
Vallingby, Sweden

Frank Ollie  
Defence Research Tele-  
communications Establishment  
Ottawa, Ontario, Canada

W. J. A. M. Pajmaus  
Dr. Neher Laboratory  
Leidschendam, The Netherlands

D. W. Parker  
Mullard Research Laboratories  
Redhill, Surrey, England

R. Willis Parlin  
University of Minnesota  
Minneapolis, Minnesota

Wayne Payzant  
University of California  
Lawrence Radiation Laboratory  
Livermore, California

Note: Due to the lack of space in this issue, several new members slated for this issue have been omitted. These names will appear in the next issue.

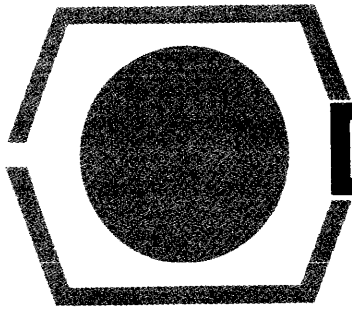

# DECUSCOPE

DIGITAL EQUIPMENT COMPUTER USERS SOCIETY

1966  
Vol. 5 No. 10



BEST WISHES FOR HAPPY HOLIDAYS

FROM

THE DECUS STAFF

*Angela J. Cassette  
Bonnie McCabe  
Kita Lalli  
Jeanne Eastwood*



## INFORMAL MEETING IN HOLLAND

M. A. A. Sonnemans  
Institute for Nuclear Physics Research  
Oosterringdyk 18, Amsterdam, Netherlands

The number of PDP computers in Holland increases rapidly. At this time there are three PDP-7's, one PDP-5, and six PDP-8's installed, while there are still six PDP-8's and one LINC-8 to be delivered.

In order to stimulate mutual collaboration and informal communication between close living neighbors, a meeting of Dutch PDP users was arranged recently. This informal meeting was held September 27th at the Institute for Nuclear Physics Research (I.K.O.), Amsterdam. It was attended by 31 people, representing the following organizations: Hoogovens IJmuiden, dr. Neher Lab., Technische Hogeschool - Delft, University of Nijmegen, Applied Physics Research (T.N.O.) - Soesterberg, ESTEC, Applied Dynamics, Philips Duphar and I.K.O.

(Continued on Page 2)

# Table of Contents

Informal Meeting in Holland . . . . .	1,2
Synopsis of Second DECUS European Seminar . . . . .	2,3
Data Acquisition and Control in a Time-Shared Environment . . . . .	4,5,6,7
PDP-8 System Summary . . . . .	8,9
The Linking of a FORTRAN and Machine Language Program on PDP-7 FORTRAN System . . . . .	10,11
News Items . . . . .	12
Programs Available from Authors . . . . .	12
New DECUS Members . . . . .	12,15, 16
DECUS Program Library . . . . .	13,14
Call For Papers . . . . .	Insert
"Letters" . . . . .	Insert

# Synopsis of Second Decus European Seminar

The second Seminar for European DECUS members was held at the University of Aachen on Tuesday and Wednesday, October 25 and 26, 1966.

Brian Macefield, University of Oxford and Helmut Karl, Aachen chaired the sessions. Approximately 40 people attended. Seminar proceedings are now being prepared and should be available in January. The next European Seminar is scheduled for either September or October 1967 in Amsterdam. European Seminars will be held annually in the future.

An outline of the program and abstracts of some of the papers follow.

## PROGRAM

### TUESDAY - OCTOBER 25

#### Morning Session

##### Registration

Discussion - DECUS policies and aims in Europe.

#### Afternoon Session

A Simple List Processing Package For The PDP-7, N. E. Wiseman, University Mathematical Lab., Cambridge

A Re-entrant Procedure For Minimal Core Usage In An On-Line Measuring System, C. L. Jarvis and K. Muller, Physikalisches Institut, Bonn

Measuring Machines On-Line to a PDP-8, D. E. Lawrence, Nuclear Physics Dept., Oxford University

Organization of Fast Data Transfer With The PDP-8, H. Karl and C. Stolze, III Physikalisches Institut, Aachen

Hybrid Computer Studies On Control Systems, G. Olsson, Royal Institute of Technology, Stockholm, Sweden

### WEDNESDAY - OCTOBER 26

#### Morning Session

##### DEC policies and plans.

- Nick Mazzaresse - Small Computer Product Line Mgr.
- Jim Murphy - PDP-9 Programming Group Leader
- John Leng - European Manager
- Ken Senior - European Field Service Manager
- Ray Jones - European Programming Group

##### Discussion

#### Afternoon Session

Initial Nuclear Structure Experiments With PDP-7, P. J. Twin, Nuclear Physics Lab., Liverpool University

Ideas For A Comprehensive PDP-5/8 Programming System For Computers With 8K Of Memory and DECtapes, F. Akolk, DESY, Hamburg

DECUSCOPE is published monthly for Digital Equipment Computer Users Society (DECUS).

Material for publication should be sent to: Angela J. Cossette, DECUS, Maynard, Massachusetts 01754. Telephone: AC 617 897-8821, TWX 710 347-0212

Publications Chairman: Joseph Lundy, Inforonics, Inc.

Circulation: 1,885 copies per month

DECUS acknowledges the assistance of Digital's Technical Publications Department in the preparation of this newsletter.

#### Informal Meeting Continued from Page 1

In a number of short introductory talks, information was presented about the applications of the machines by several groups of users. The discussions subsequently affirmed that better contact between the groups was generally appreciated. It was, therefore, agreed that the groups would frequently send informal notes concerning their software and hardware problems, desires and experiences to Mr. M. A. A. Sonnemans at I.K.O., who would then distribute them to all groups.

In the discussion about experiences with the computers the problems and proposals reported by the DECUS European Committee after the first DECUS meeting in Europe were strongly supported.

PDP-10 System Philosophy, G. Moore, D.E.C., Germany

PDP-8 Supervisor (Task Management), H. Frese, DESY, Hamburg

Data Collecting System For Neutron Beam Experiments, E. E. Maslin, Herald Reactor, A.W.R.E., Aldermaston, Berkshire

## ABSTRACTS

HYBRID COMPUTER STUDIES ON CONTROL SYSTEMS  
G. Olsson, Royal Institute of Technology, Stockholm

At the Department of Automatic Control, a PDP-7 computer, which was delivered about a year ago, is mainly intended to be part of a hybrid system to be used as a real-time simulator of real computer control systems. The analog unit is a PACE TR-48. The PDP has an 8K core memory, an EAE unit, a 16-channel multiplexer with A-D converter, 8 D-A converters, 16-channel automatic priority interrupt, the relay buffer type 140, DEC tape dual transport type 555 as well as a 17-inch CRT display.

The largest part of the interface has already been built, and at present, we are developing further facilities. These include ancilliary equipment, which is necessary in order to control the various parts of the hybrid computer. This equipment includes input and output digital registers and a high-precision clock as well as electronic comparators.

The particular problems which we are trying to treat can be divided into three classes, depending on how the digital and the analog units interact. This talk is intended to be a survey of the approach we are using or will use when developing the interface.

INITIAL NUCLEAR STRUCTURE EXPERIMENTS WITH THE PDP-7

P. J. Twin, Nuclear Physics Laboratory, Liverpool Univ.

A programming system has been developed to carry out on-line nuclear structure experiments, in particular, gamma-ray angular correlation experiments. One such experiment will be described in detail to illustrate the facilities of the program in setting-up and running the experiment. A brief outline of the way the program is arranged will also be given.

A SIMPLE LIST PROCESSING PACKAGE FOR THE PDP-7  
N. E. Wiseman, University Mathematical Lab., Cambridge

In computers such as the PDP-7 it is not possible to store list structures in the conventional manner since the word

length is too short to hold two core addresses. The obvious approach is to allocate two words to each list cell, but in a small-store machine this seems an unreasonably extravagant use of store. This paper proposes an alternative method which can, under certain circumstances, economize in storage space for a given structure at the expense of processing time.

DATA COLLECTING SYSTEM FOR NEUTRON BEAM EXPERIMENTS

E. E. Maslin, Herald Reactor. A.W.R.E., Aldermaston

A description is given of a data collecting system using the PDP-8 to serve the needs of several experimenters using neutron beams from the Herald Research Reactor at A. W. R. E., Aldermaston. A 4K PDP-8 operates in a time-shared mode allowing simultaneous data monitoring from one four-parameter experiment, data transfers from one conventional analyzer and time-of-flight analysis using the data break. In addition, either an "interruptable" version of the full multi-channel analyzer program can be used for more effective display and handling of data or as an alternative an "interruptable" version of the Editor program can be used. Either of these programs can be loaded and used without disturbing data collection.

MEASURING MACHINES ON-LINE TO A PDP-8

D. E. Lawrence, Nuclear Physics Dept., Oxford Univ.

The Bubble Chamber Group of the Oxford University Nuclear Physics Department has interfaced five measuring machines to a PDP-8 computer. The program checks that the format of the measurement is perfect, and also checks the position of fiducials and the smoothness of points on a track. No three-dimensional reconstruction is attempted.

A RE-ENTRANT PROCEDURE FOR MINIMAL CORE USAGE IN AN ON-LINE MEASURING SYSTEM

C. L. Jarvis and K. Muller, Physikalisches Institut, Bonn

Four measuring machines will be connected on-line to a 32K PDP-6 through a standard interface and controlled by a supervising program "MPUP." A re-entrant procedure is described that allows core-sharing by the users of "MPUP" within the time-sharing environment.

The main advantage of the technique adopted is that core usage is minimized in the sense that the user program requires a common 2K of core and in addition 1K for each measure job. Necessary monitor modifications and coding conventions are discussed.

# Data Acquisition And Control In A Time-Shared Environment

By I. G. NICHOLLS,  
Computing Centre, The University of Western Australia,  
Nedlands, Western Australia

## SUMMARY

The relevant roles of computer hardware, the time-shared monitor, the user program and the device interface in on-line systems are discussed in relation to three of the on-line projects at the University of Western Australia. One of the main conclusions drawn is that in a University environment there exists a large number of small projects suitable for on-line operation. Many of these could be serviced by a general purpose interface with multiplexing of analog inputs and re-entrant service routine thus reducing cost and core requirements.

## 1. INTRODUCTION

From the point of view of many scientists and engineers, one of the consequences of the advent of digital computers is that more complex experiments can be undertaken.

This complexity is being introduced in two directions. The first is in the acquisition of large amounts of data, often low grade. The simplicity of either on-line real-time data reduction, or just collection for later machine reduction and analysis, lends itself to this approach, thereby improving the statistics of the information obtained.

The second area of interest is where the experiment is complex itself, and the use of on-line real-time computing is advantageous in decision making, or in displaying progressive results, providing the scientist with an "all systems go" indication as the experiment proceeds. This can be important if the experiment is long and tedious to perform, or costly, as in nuclear research where nuclear reactor programs are tied to particular experiments.

Confusion exists over the definition of the words "real-time." Some authors use the term to describe the operation of any device which is answered by the computer almost immediately. In this paper the phrase "real-time" is used only when there is a time limit for the completion of a particular computation. All other devices are merely on-line devices. Thus a card reader with no buffer, reading column by column is real-time because, having read one column, this data must be digested before the next column has passed the read head.

When computers first appeared they were big, clumsy, expensive and not the most reliable, and consequently although they were used to analyse experimental results, they were not often used to collect data on-line. The notable exception was in the military field. These disadvantages have, to a large extent, been overcome and other improvements such as the introduction of an interrupt line introduced. With the further step to time-sharing of computers, one can truly justify on-line data acquisition and control, utilizing a medium to large time-shared (T.S.) computer.

A real-time program may not use 100% of the central processor time but it must have access to the central processor when it is desired, and for as long as is necessary. These requirements are not incompatible with time-sharing. Indeed, several real-time programs can be time-shared providing their real-time constraints are compatible.

In the operation of a T.S. computer, a user program is run under control of some of the monitor routines and can call

others as part of its own program. One of these latter routines forms a communication link with the on-line device via an interface.

The cost, speed and flexibility of any on-line or real-time system is determined by the user program, the time-shared monitor and the interface to the device, together with the hardware features of the computer. These factors will be discussed in terms of three on-line programs using a DEC. PDP-6 at the University of Western Australia. The PDP-6 is a standard commercial machine with hardware and software features to enable its use as a time-shared system.

The three projects are a spectrometer real-time data acquisition system, a diffractometer on-line control and data collection configuration and a similar but real-time arrangement for a hybrid link.

## 2. COMPUTER HARDWARE

The research worker often has no choice in the computer hardware if the installation is a general purpose computing centre. However, there are several desirable features for real-time computing. These include a fast cycle time and high-speed arithmetic allowing calculations to be done even at high sampling rates. Parallel processing would also be advantageous.

A necessary requirement is an efficient Priority Interrupt (P.I.) system. In order to communicate with the computer, a device makes a request; often this may be in the form of a P.I. Several different systems are in current use. One simple method is a sequential scan of all external devices. A single P.I. level where a request to the computer is the logical "OR" of all device interrupt demands is a second method, and a third is a multilevel P.I. where each device has its own interrupt line to the computer.

This latter type of P.I. system has several advantages over the other types. The reaction time, or time between the occurrence of a signal external to the computer and the commencement of execution of the first useful instruction requested by the external signal can be kept to a minimum, whereas the reaction time of a sequential scan interrupt system can be very long.

The overhead, or difference between total time necessary to process completely the incoming request and execution time of all useful instructions, can also be kept to a minimum.

The PDP-6 has a seven level or channel P.I. system. When an interrupt occurs the computer traps to location  $40 + 2j$  (where  $j$  is the number of the P.I. channel) and executes that instruction. Each channel may have more than one device associated with it. Thus it is a combination of the second and third types described above.

If only one device is used per channel (acting like a multilevel system) the reaction time can be reduced to less than one instruction time as the P.I. request flip-flops are strobed at the commencement of every instruction to see if a request is present, and again between 400 nano secs. and 2 micro secs. after the instruction has commenced. If multiple indirect addressing is carried out the request flip-flops are strobed on a one-for-one basis.

If more than one device is assigned to a channel (similar to a single P.I. level) then the reaction time is increased by at least the number of instructions it takes the processor to decide which device on that line requested an interrupt.

Again, assuming one device per channel, the overhead can be reduced to virtually nothing for simple input or output, as only one instruction is sufficient and this can be carried out without affecting the state of the machine (program counter, flags or accumulator contents). Under this condition the maximum data acquisition rate would be 6,000,000 bits/second.

The P.I. levels are nested and a request is serviced immediately if no request on a higher or the same channel is being serviced. Under these conditions, the request is inhibited until the higher one has been executed and dismissed. A request on a higher channel may interrupt the servicing of a request on a lower channel.

## 3. TIME SHARED MONITOR

The PDP-6 T.S. monitor<sup>3 5</sup> provides the overall co-ordination and control of the total operating system, handling all input/output (I/O) and carrying out the error detection necessary in

\*Note: This paper was presented at the Australian Computer Conference, Canberra, Australia in May 1966. We have reprinted that article directly from a reprint received from the University of Western Australia. The photographs which were referenced as figures in the article were not reproducible and therefore had to be eliminated.

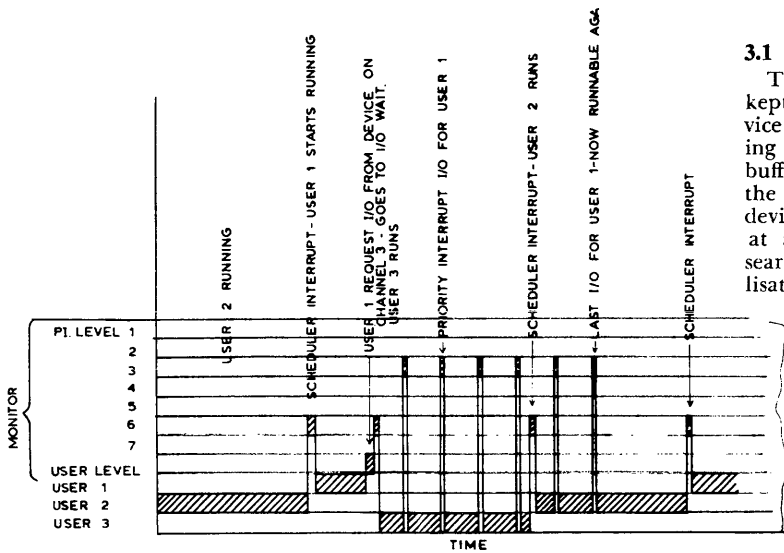

FIGURE 1: SIMPLIFIED DIAGRAM ILLUSTRATING PRIORITY INTERRUPTS

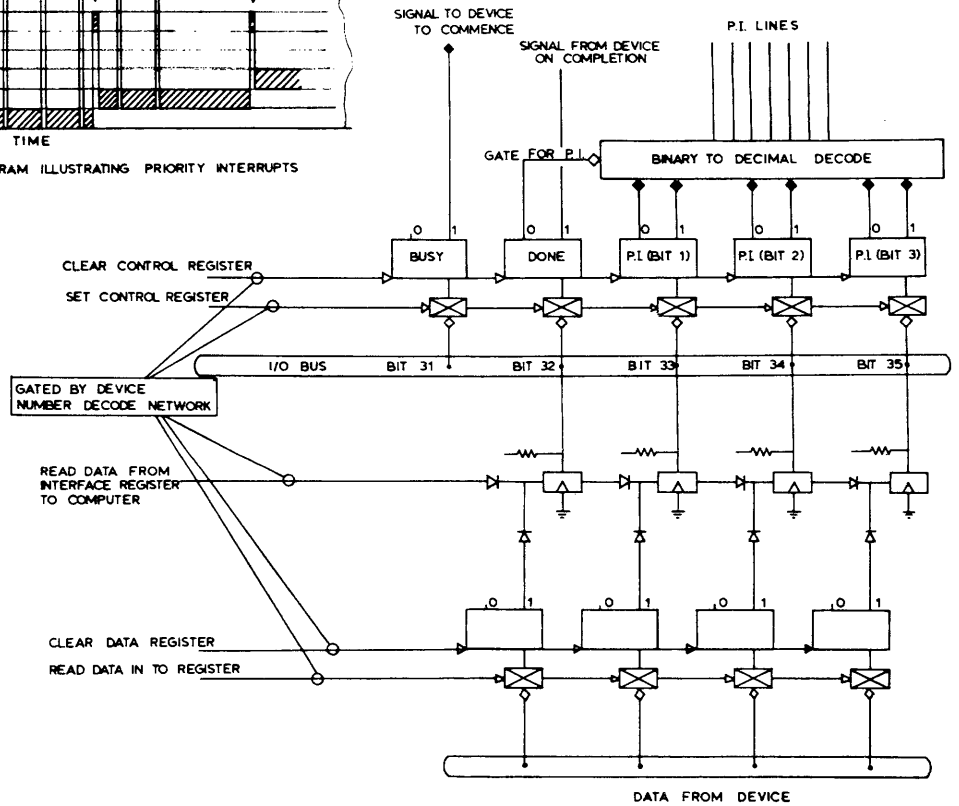

FIGURE 2: SIMPLIFIED LOGIC DIAGRAM SHOWING TYPICAL ARRANGEMENTS OF CONTROL AND DATA REGISTERS

a time-shared system. It is of modular construction; most sections are re-entrant and it is organised to switch between jobs fast enough so that all programs appear to run simultaneously. In fact, the central processor spends 300 milli seconds on one job and then swaps to another unless, during the first job, it comes to an I/O instruction. If necessary, this job is then put into an I/O wait, (until an input buffer is full, or output buffer is empty) and control is immediately transferred to the next job. In 300 milli seconds around 60,000 operations can be executed, so the majority of jobs do not last their full time. The "round robin" principle is modified to give priority to jobs which have just completed I/O operations. These are handled in two parts by the monitor. The first part is device independent. This is re-entrant and used by all devices. It is executed at normal user level and is treated as an extension of the user program. The second part is the device dependent service routine. This handles the actual I/O and is carried out at an assigned priority level during the running of other jobs. This overlapping of I/O with computation, and multi-programming where applicable, is illustrated in Fig. 1.

Extensive alterations and additions have been made to the monitor to allow for the extra devices added on-line.

The dispatch table for each device contains the starting addresses of the device dependent input or output routine, the shut down, the interrupt and initialisation routines.

The main one of interest, in this application, is the interrupt routine. This will be called by a physical situation causing a P.I. and must return control to the interrupted program. As levels are nested, facilities to save the state of the processor

### 3.1 The Structure of a Real-Time device Service Routine

The structure of the added routines has, where possible, been kept compatible with those of normal I/O devices. Each device has an associated data block which is used for bookkeeping and contains such information as the device status, the buffer size necessary for its operation, its priority channel, and the device number to which it is currently assigned. These device data blocks are dynamically linked into one long table at assembly time. When I/O is first requested by a user a search is performed using this table and the appropriate initialisation is carried out.

at each level are included. These facilities are common to all devices in one level but they must exit each call before they can be referenced again, so like the device service routines they need not be re-entrant. However, they may call re-entrant routines that are common to the rest of the system.

The interrupt routines should be as short as possible and contain a minimum of computing, especially on the higher channels, i.e. the computer should be running under priority conditions only when really necessary, so preserving the meaning of priority. Notwithstanding, running real-time programs may occasionally necessitate large amounts of computing at interrupt levels.

As mentioned previously, for standard input or output of data, P.I. routines of only one instruction are sufficient if only one device is on each P.I. level. In the present University configuration this is done when using magnetic tapes (Channel 1) where the transfer rate is 15,000 characters per second, and for the display (Channel 7). In this case, although the transfer rate is high the display is not real-time and the main reason for using a whole channel is to keep the interrupt routine to a minimum, as it may be executed  $2 \times 10^7$  times in a 10-15 minute run using the display. Once users begin utilising the display, ten minutes is not a long run.

If more than one device is assigned to each channel then program counter must be saved and a search made for the device causing the interrupt. All devices using the same channel are set in a flag chain (2 instructions per device) which is dynamically linked by system initialisation.

Most real-time interrupt routines need some computation so any accumulators to be used must have their contents saved



and the computation can then proceed. When this is finished the accumulators must be restored and the interrupt dismissed.

The P.I. level associated with each device and the order on any level is under monitor control, giving flexible adjustments as devices are added or altered.

### 3.2 Priority Channel Assignments

The channel assignments for the University computer are shown in Table 1.

**Table 1. DEVICE CHANNEL ASSIGNMENTS FOR PDP-6**

Priority Channel	Devices in Order of Interrogation
1.	Magnetic Tapes
2.	Card Reader, Hybrid Link, Rat Race
3.	Paper Tape Reader, Line Printer, Scanner
4.	Magnetic Tape Control Unit, Display Special
5.	Diffractometer, Spectrometer, Camera
6.	Scheduler and Command Decoding
7.	Display Data

The spectrometer is included on Channel 5 as the sampling rate is so slow (5-10 samples/sec). The hybrid link is given high priority not for high transfer rates, but to minimise delays between the two computers (1 milli sec. at 10 c/s represents a phase shift of 3.6°). The diffractometer is fully asynchronous in its relation to the computer and will be in operation for long periods, so it has been placed first on Channel 5. This reduces overhead as it will be the first device interrogated on this channel.

Other unusual devices are the Rat Race which is a real-time psychology experiment that uses the scheduling clock as a timer. Therefore it must be placed higher than the clock routine. The camera interface is to enable program control of a camera which is associated with the display. It is fully asynchronous with a very low repetition rate. The display itself is asynchronous and has been mentioned before.

### 4. USER PROGRAMS

For control and data acquisition the user program requirements will vary from project to project. Flexibility may be sacrificed for speed or vice versa. The division of labour between the user program and the monitor routine is also important.

For pure data acquisition user programs are straight forward. This is illustrated by the spectrometer program where the only unusual feature is the buffer ring which is large enough to hold data collected over 2½ minutes. Once the computer commences collecting data from the interface, it must continue to do so at regular intervals specified by the spectrometer. These data are stored in the buffer ring and written on tape when the user program is again "runable" and it has access to the tape control unit. This unit controls all tape drives and can be tied up by other users for periods up to 40 seconds.

As long as the user has access to the control unit at 2½ minute intervals or less, no buffers are overwritten and no data are lost.

For the diffractometer, speed is important as the same program will be run continuously. Basically instructions are sent to the diffractometer. These are executed and an interrupt returned to the computer to acknowledge completion. If the instruction requested information from the diffractometer a flag is also set and the desired information is put into a register at the computer interface. The computer, noting the set flag, reads this information, stores it and issues the next command. The instruction and data are then recorded on magnetic tape. The user program supplies a buffer of instructions and blanks to the service routine which carries out all input, output, checks and tests in one P.I. interrupt routine. To change this routine it is necessary to make a new monitor system which is not a flexible arrangement. The alternative would be the user program sending out small batches of instructions to the diffractometer interspersed with requests for information. As the time taken to execute the linkages between the monitor service routine and the user program is significant in relation to the size of the interrupt routine this would be much slower.

The opposite approach has been taken for the hybrid link. User requirements will vary enormously so no general program could be written. The idea adopted here was to develop sub-routines to handle 1/0 to the analog computer. These are called as ordinary subroutines, e.g.:

CALL HYIN (K,N,M) and this would be interpreted as  
READ ANALOG I, (K(I),I = N,M)  
I FORMAT (I4)

Thus, using FORTRAN the analog computer I/O can be treated similarly to that of any other device. This allows the user to carry out any operations on data or instructions in a flexible, simple manner, but it does so by sacrificing some speed.

### 5. INTERFACES

The PDP-6 has a single I/O bus, to which 126 devices may be attached. Each device has an interface which contains a decode gating network to select its own code number and allow communication with the computer.

The normal interface has two registers, a control and a data register. The operation of the device is completely specified by the bits of the control register which may be set by a computer instruction. The device can also set some of these bits which in turn can be examined by the central processor. Thus, if an input is requested, the computer sets a busy flag in the control register. The device stores data in the data register and sets the done flag in the control register. This enables an interrupt on a particular P.I. channel, forcing the processor to service the device and store the data in a dynamic buffer area in core.

If each sample is only 6 binary bits, 6 samples may be collected at the interface before causing an interrupt, i.e. one can trade off the cost of a larger interface against the time saved in executing the interrupt routine.

The spectrometer interface has a data register consisting of 24 bits. This represents a single 6 digit B.C.D. number. The diffractometer is different, having 2 data registers, an output one of 5 bits (a 5 bit instruction code is used) and an input register of 4 bits. The cost of increasing the interface and the control logic of the diffractometer did not justify the speed increase of fewer interrupts. This interface was extended to 12 bits for input and 13 for output for use with the analog link. The control register is the same for both applications and contains error bits and data-in-ready bits as well as the usual busy, done, and P.I. channel number bits.

Figure 2 illustrates a simplified interface to read in 4 bits of information per interrupt. The standard D.E.C. symbols<sup>4</sup> are used in this figure.

### 6. COMMENTS ON THE ON-LINE PROJECTS

The spectrometer was the first extra real-time device coupled to the PDP-6 and was first time-shared on an experimental basis in July, 1965.

There are two mass spectrometers—a conventional 6 inch radius, 60° deflection solid source unit and an all metal bakable spectrometer for rare gas analysis (Figures 3a, 3b). Either may be plugged into the computer interface. One of the studies at present being undertaken is a comparison of terrestrial tin with that obtained from meteorites. Tin has ten isotopes so the data accumulated by a series of sweeps is fairly heavy. As tin is difficult to ionize efficiently, the useful beam level is approximately 10<sup>-13</sup> amperes. Consequently noise was significant and peak selection difficult<sup>8</sup>.

Originally, the output was produced on a strip chart. Ruler and pencil were used to measure peaks and a hand calculator used to determine results. When the University acquired an I.B.M. 1620 computer, the output was digitised and printed. The printed lists were scanned by eye. The areas around the peaks were marked in and then punched on cards for computer analysis. Results were often not analysed until a week or ten days after the samples had been run, and this had the disadvantage that if anything was wrong, a new sample had to be prepared. There was also the constant possibility of punching errors.

The following points are relevant:—

1. The cost of the computer interface was less than £1,000. (This can be compared with a quotation of £1,700 to produce the data on punched paper tape.)

2. The spectrometer uses only 1K of core and approximately 0.5% of central processor time while it is running. The remaining 99.5% can be used by other programs.

3. The sample rate is 5-10 samples per second, necessitating service of the P.I. within 100-200 milli seconds which puts no strain on the system.

4. All data can be stored on magnetic tape, removing the need for manual editing.

5. The sweep rate was increased yielding better statistics on samples with a decaying beam.

6. As a result of (5), the number of sweeps backwards and forwards per run was increased, also improving the statistics of the results.

7. The productivity rate was increased from 1 sample per day under the original system, to 6 samples per day.

8. Turn around time has been decreased from weeks to minutes. The results are known while the sample is still hot in the spectrometer and if the results look doubtful, and sample contamination or instrument errors are suspected, these can often be corrected and further runs made immediately. Moreover, the analysis of one run may be time-shared with the data collection of the next run.

9. The emphasis has been shifted completely from the tedious computation of data to the chemistry of producing samples and the techniques of spectrometry. This point is considered the most important as a higher level of continuity of effort can be maintained.

The diffractometer (Figure 3c) testing and installation are not complete so the performance of the machine cannot as yet be compared with similar off-line devices. Running it on-line has a dual purpose. Cowan states both when he says, "A few years ago the factor limiting the scope and precision of an X-ray crystal structure analysis was the lack of proper computing facilities. Now . . . the factor limiting the scope of an X-ray analysis is frequently the collection of data<sup>6</sup>." The amount of data per structure is large as a typical analysis will require accurate measurements of approximately 4,000 X-ray reflections. Also, 400 instructions are needed per reflection. It is estimated that this would take 1,000 hours by manual methods compared to 80-100 hours of unattended automatic operation. As this will occupy the central processor less than 0.5% of the time the problem is ideal for solution using a T.S. computer. In addition, by means of the interface which costs less than a paper tape punch and reader, this apparatus has been provided with direct access to a powerful computing system. This will permit simultaneous collection and processing of results which can be used to provide a feedback of information to optimise subsequent operations of the diffractometer. The analysis can be carried through to the production of Fourier maps<sup>7</sup> without the need to manually handle, sort or check the data.

The AD32 analog computer and the PDP-6 are physically 200 yards apart (Figure 3d). A 75 pair P.M.G. cable runs between the two. This particular link is for research in two directions; the first is for research into hybrid computing itself and the second for research using the link in such fields as multi-variable adaptive control systems. A monitor system combining the hybrid link and the display has been constructed to make the analog proponents feel at home.

The first time-shared experiments, made in October, 1965, were auto-correlations of signals generated on the analog computer.

## 7. CONCLUSIONS

It has been shown that time-sharing of data acquisition and control is economical and feasible in some applications. Some general comments are applicable:—

In hardware, although P.I. systems have improved vastly in the last four years there are still some aspects to investigate. Dynamic priority re-allocation is available in a limited sense under software control, but this means computing instructions which take time to be executed. Unless forewarning of necessary re-allocation is given, more time will be lost than saved. Some improved method is desirable.

If an interrupt routine with some computing is to be accessed with a high frequency, the overhead incurred by using software to save and restore the contents of the accumulators, set them up with particulars related to the interrupt and then restore their contents at the termination of the interrupt routine is significant. Improvement could be made by assigning a small set of accumulators with each of several priority levels. At present this is very expensive (on the PDP-6 a set of 16-400 nano second accumulators with associated hardware costs £15,000) but as memory speeds increase and costs decrease, it may soon be an economical possibility.

With software, adding on-line devices demands a thorough knowledge of all facets of the time-shared monitor. These are usually complex and sophisticated so any on-line proposal must be carefully examined to justify the effort involved. Any added routines must be "completely" debugged as the monitor has access to all the core.

Also the manufacturers must be willing to allow customers to experiment with, alter or add to the monitor. Fortunately,

this freedom of operation is already granted by some manufacturers but others still regard the monitor as sacred and their own property.

In this particular T.S. monitor further investigations on job-swapping algorithms are necessary. In real-time applications the ideal is simple, but for asynchronous work no simple optimum solution exists. Some sort of software priority is essential. The algorithm would need to be short, or the time in computing which job to run next would outweigh the gain in scheduling the right job at the right time.

When the present swapping algorithm was used with the first version of the time-shared display service routine, the display was often given priority as it was always finishing I/O operations. A third or fourth job was never run if the second one consisted of hard computing. The scheduler would run jobs 1 and 2 and then give priority back to 1, etc.<sup>9</sup>

The present University configuration suffers severely in the amount of high-speed memory available. This has placed severe restrictions on the number of on-line projects that have been undertaken, and in addition has necessitated the computations in the user program to be reduced to a bare minimum (most run in 1K of core) as they are resident in core for long periods. If the configuration were expanded to a swapping system only the buffer areas would need to remain in core. However, the little work already carried out indicates the full benefits that can be derived for some applications.

Within a University research environment there is a multitude of equipment and particular experiments which can easily and usefully be automated to some extent using a T.S. computer.

Although the interfaces mentioned are related to particular projects they are, to a certain extent, general purpose interfaces, e.g. The Rat Race uses the spectrometer interface, the present hybrid interface is an extension of the diffractometer interface, and this has also been used to feed real-time data from a television picture via a sampling oscilloscope to the computer.

With these two points in mind the design of a general-purpose interface to handle an analog signal from any device and record the information is desirable. This idea can be extended to include multiplexing of the input signals to allow the same interface to be used by many different users. In addition, the monitor routine can be made re-entrant and special user subroutines written to access the monitor routine.

This would provide a data collection system with minimum core requirements that would be utilised by several users simultaneously with FORTRAN programs. A further advantage is that the monitor routine need not be altered for every device.

Computing science is a fast developing profession and as this branch becomes more important the near future could see the computing centre physically situated in the middle of a large group of laboratories used by various disciplines on-line and real-time work.

## 8. ACKNOWLEDGMENTS

The device interfaces discussed were designed by Mr. R. Frith of D.E.C., whom the author thanks for many stimulating discussions.

The diffractometer user program was a joint effort with Dr. E. N. Maslen, who is a Senior Lecturer, Department of Physics, University of W.A.

## 9. REFERENCES

- (1) EMIL R. BORGERS, (1965) "Characteristics of Priority Interrupts". *Datamation*, 6, p. 31.
- (2) DANIEL N. COOPER, (1964) "The Automated Laboratory". *International Science and Technology*, 36, p. 20.
- (3) THOMAS N. HASTINGS, (1965) "Real-Time Computing While Time-Sharing". *Computers and Automation*, 10, p. 28.
- (4) "Digital Flip-Chip Modules" (1965). Digital Equipment Corporation, Maynard, Massachusetts.
- (5) "PDP-6 Multiprogramming System Manual". Digital Equipment Corporation, Maynard, Massachusetts.
- (6) JOHN P. COWAN et al (1963) "CASCADE: An Automatic Single-Crystal X-ray Diffractometer". *Acta Crystallographica*, 16, p. 221.
- (7) A. RAE, (1966) "Fourier Maps using a High Speed Precision C.R.T. Display". To be published.
- (8) P. J. HAGAN and J. R. DE LAETER (1966) "Mass Spectrometric Data Processing using a Time-Shared Computer". To be published.
- (9) D. W. G. MOORE and M. J. ERICKSON, (1966) "The Display as a Research Tool". *Proceedings Australian Computer Conference, Canberra*. (This Volume.)

# PDP-8 SYSTEM SUMMARY

Richard M. Merrill  
 Digital Equipment Corporation  
 Maynard, Massachusetts

This is not a program, but a concise summary of the commands and procedures used with the most frequently run system programs. It is a good reminder to have at the

console and especially useful for beginners. Applies to PDP-8, 8/S, and 5.

PAL III SA: 200<sub>g</sub> bits 0&1 (pass #)  
 Expunge, FIXMRI, FIXTAB, DECIMAL, OCTAL, bit 11 (tape)  
 PAUSE, FIELD EXPRESSION 0-  
 1-

DDT SA: 5400<sub>g</sub>  
 New symbols: Bit 0=0; ["R+ +L.F." "xxx nnnn" ] ↘ +L.F.+EOT"  
 Bit 0 (TAPE) 1-L then continue ←  
 0-H  
 New symbol tape: "R.O.+C.R.+L.F." "xxx nnnn" "C.R.+L.F.+EOT"

+	=	K[Break	[E checksum
-	.	N[Continue	[A accumulator (at breakpoints)
/	←	K[Go	[Y link
C.R.	[Symbols	[R	[Mash
L.F.	[Octal	[T	[Lower limit
↑	N[W	a;b[P	[Upper limit

MACRO-8 SA: 200<sub>g</sub> - For high-speed version, patch 0004 with 0600 to punch listing (pass 3)

<u>Switches up</u>	<u>Function</u>
None	Go to next pass
0	Permanent symbols only; go to pass 1
1	Pass 2
2	Retain symbol table; go to pass 1
3	Pass 3 → pass 1
10	Delete double precision processors
11	Delete macro and number processors

SYMBOLIC EDITOR SA: 176<sub>g</sub> (KILL) → 177<sub>g</sub> (C.R.L.F.) → 200<sub>g</sub> (INIT1)

Keys	Commands	Commands
C.R. - complete action		Read (high speed)
[F.F. - command mode		Append (low speed and/or keyboard)
← - cancel line		Kill
[TAB - tabs		n Delete
		n, m D
bits		n Insert
1 = 1 to suppress		Change
· tabs on output		List (low)
		Punch (high)
		F punch form feed code (high)
Arguments		T leader trailer (high)
/ last line		n N read, punch, kill, read etc.
. current line		
= decimal value		
n line number		
"alt mode" = .u1L)		
< = .-1L)		
⌋ = +		

CALCULATOR SA: 200g

Commands:	Priorities:	Terminators:
Rn - repeat	( )	=
[ ] - modification	↑	;
FOR (n,d)	ABS	[ = Shift + K
FOR (E)	SQT	] = Shift + M
	SIN	
	COS	
<u>FORMAT GENERATOR</u>	ATN	
SA: 200	EXP	
SR <sub>0</sub> -0 ASR33	LOG	
-1 750	*,1	
SR <sub>1</sub> , -0 SPACES	-	
-1 TABS	+	
	=	

LOC	OCTAL	JOB
353	5752	No tabs or spaces
611	5206	No blanks
614	5206	No form feed
617	5206	No leader
305	5271	No comments
333	5336	High speed
333	5344	Low speed
053	0273	Delimit tags
034	0000	Pass 0's
664	0000	Pass 1's

FORTRAN

Compiler Diagnostics

Dynamic Correction mode: SA: 200g; SR: 7777g

xxxx	xx	xx
Number of last label	Relative Label Count	Error Code
0 Mixed Modes		Execution Diagnostics
1 Double Operators		
2 Compiler's Error		11 Divide by zero
3 Illegal Comma		12 Gross Exponent
4 Excess Operators		13 Program Modification
5 Fixed Argument		14 Location Zero
6 Floating Subscript		15 Non-Format
7 Excess Variables (64)		16 Format Error
10 Gross Program		20 sqrt (imaginary)
11 Paren. Mismatch		21 Reg. to power
12 Illegal Character		22 Log of zero
13 Format Error		
14 Unused Number		76 Underflow
15 No. Oper or Bad Dimension		77 Overflow
16 Too Long (128)		
17 Bad Operand		
20 Undefined Label		
21 Excess Statements (40)		
22 Excess Nesting		
23 Excess Undefined		

# The Linking of a Fortran and Machine Language Program on the PDP-7 Fortran System

K. W. Bixby  
 Philco Corporation, Aeronutronic Division  
 Newport Beach, California

The key to linking two such programs together is through the psuedo-commands EXTERNAL and INTERNAL. One must compile the FORTRAN, then using the FORTRAN Assembler, assemble the FORTRAN intermediate source and the machine language program together. The link-up of common symbols and arrays is accomplished at this time. The proper use of the EXTERNAL and INTERNAL commands to accomplish the desired ends is outlined in the following paragraphs.

Basically, the question a programmer might ask is: How can a FORTRAN program access addresses in a machine language subprogram without including all of the machine code in the FORTRAN program through the use of the S code? The answer as one will soon see, is yes it can be done.

Having exhaustively pursued, with able assistance, this problem; some rewarding conclusions were made.

## A. Individual Symbol Linking

Apparently all symbols used by FORTRAN and Machine Language programs must be defined within the Machine Language program by using the INTERNAL command immediately preceding the definition of the symbol.

The link-up is accomplished by also preceding the use of the symbol in the FORTRAN program, with an EXTERNAL command. The EXTERNAL must be placed within the FORTRAN by the use of the S code, for machine language input in a FORTRAN program.

The symbol must appear on the right side of an equal sign, and in the data list of an I/O statement. In other words, it must not be defined in the FORTRAN program.

For example:

FORTRAN Program:

```

:
:
S  EXTERNAL LOC1., LOC2.*
  IK = LOC1+LOC2
:
:
S  EXTERNAL LOC3.
  WRITE 2,100, LOC3
:
:
END
  
```

Machine Language Program:

```

:
:
INTERNAL**LOC1.
***LOC1., Ø
:
:
INTERNAL LOC2.
LOC2., Ø
:
:
INTERNAL LOC3.
LOC3., Ø
:
:
START
  
```

\*The compiler places a period on the end of all symbols five characters or less used in the FORTRAN program. Therefore, the period must be part of the symbol definition within the machine language program (if five characters or less).

\*\*The rules governing the use of EXTERNAL and INTERNAL as outlined in FORTRAN Relocatable Assembler must be followed to avoid errors.

\*\*\*Symbols used by both types of programs must be in the same mode; FIXED or FLOATING POINT.

## B. Linking of a Machine Coded Subroutine Called by a FORTRAN Program

The following example can best illustrate this procedure.

FORTRAN Program:

```

:
:
S  EXTERNAL SCANIN
S  jms SCANIN
:
:
END
  
```

Machine Coded Program:

```

INTERNAL SCANIN
SCANIN, Ø
:
:
jmp I SCANIN
START
  
```

The use of the period in the symbol is not necessary since the call is executed in machine coding in the FORTRAN program.

### C. The Linking of Arrays

Here again the definition and dimensioning must be done in the machine language program.

A dimension statement generates the following coding by the compiler.

```

NAME,      jms CALSB
           LAW TWO
           LAW THREE
           LAW FOUR
           LAW INTDIM
           ADR
    
```

This sequence supposes a four-dimensional array, CALSB is the name of the subscript calculating section of the Object-Time System. TWO, THREE, and FOUR stand for actual values of the second, third, and fourth bounds of the array. INTDIM will equal 1, 2, or 3, respectively, fixed point, two-word, or three-word floating point. The symbol ADR actually defines the address of the array. Subsequently, for a three-dimensional array delete the LAW FOUR instruction, and for a two-dimensional array delete the LAW FOUR, and LAW THREE instruction, etc.

Now this sequence must be specified within the machine-coded routine, along with the location of ADR. Space must also be allowed for (starting with ADR) the number of locations within the array.

An INTERNAL command must precede the array name definition.

In the FORTRAN program, one does not need to dimension or use common for the array. But, use the array as one would normally do so in FORTRAN statement. The compiler automatically generates an EXTERNAL command for an array name if it is not dimensioned.

Thus, the machine-coded routine need only access ADR, not the array name. For example:

Assume IARAY is a two-dimensional array of 25 locations as such (5, 5):

FORTRAN Program:

```

:
:
:
IARYA (N, M) = 5
:
:
:
END
    
```

FORTRAN compiled:

```

EXTERNAL IARAY.
CAL IARAY.
ARX #N
    
```

```

ARX #M
LAC (5)
DAC I TEMAD
:
:
:
START
    
```

Machine Language Program:

```

:
:
INTERNAL IARAY.* /The array name
IARAY.,      jms CALSB
           LAW 5 /Second Bound
           LAW 1 /Fixed point mode
           ADR /Actual address
:
:
:
ADR,        Ø
ADR+308 / Ø
:
:
:
LAC (10 /Accessing ADR
DAC ADR /Instead of IARAY
:
:
:
    
```

\*The use of the period follows the same format as that of the symbolic address outlined in A.

### D. Linking of Arrays through a FORTRAN Main Program, A FORTRAN Subroutine and a Machine Language Subprogram

Fortunately, the procedure as outlined in C for FORTRAN and machine language programs also works here. However, one must remember to use the same array name in both FORTRAN programs, and not dimension them or use common.

In conclusion, it was found that perhaps the best way to link-up symbols and arrays is put everything in arrays.

In other words, symbols would be put in single dimension arrays. The set-up is the same as described in C.

The convenience of this method is that the FORTRAN program need not have a lot of EXTERNAL commands for every symbol to be linked. And the only place where the mode should be the same is in the naming of the array. Thus, the machine language program can address directly the locations and they can be named in any manner within the program.

# NEWS ITEMS

## FOR SALE - USED PDP-1'S

PDP-1 with 16,384 words Core Memory, 16 Channel Sequence Break System, High Speed Multiply-Divide - 90 day warranty. \$75,000

PDP-1 Type 170 Core Memory - 16,384 words - 90 day warranty. \$25,000

Contact: Robert Lane  
Digital Equipment Corporation  
Maynard, Massachusetts  
Phone: AC 617, 897-8821, ext. 646

## WANTED - 8K PDP-4

User wishes to purchase one 8K PDP-4-

Contact: Dr. David Leith  
Stanford Linear Accelerator  
Stanford, California

## "LETTERS"

It was recently suggested by several DECUS members that DECUS publish letters of general interest as a separate insert to each publication of DECUSCOPE. These letters would consist of correspondence between users, to DEC personnel as well as letters written directly to the DECUS office.

Included in this issue are several letters recently received at the DECUS office. We would appreciate your views on this section and whether you would like to see it continued.

Submission to "Letters Insert" should be directed to Angela Cossette, DECUS, Maynard, Massachusetts.

Please send in originals or first carbons of letters you feel would be of interest to others.

## PROGRAMS AVAILABLE FROM AUTHORS

Computer: LINC

Title: Datamec Diagnostic

Author: D. W. Hazelton, University of Wisconsin, Biomedical Computing Center, Madison, Wis.

This program checks Datamec tapes for accuracy and also contains several "hardware" service routines.

The general user will find this program useful for checking CDC compatible tapes. Specifically, the check section tests in even or odd parity for the following:

1. Lateral Parity Errors
2. Missing Record Characters

3. Missing Longitudinal Redundancy Check Character (LRCC's)
4. Longitudinal Parity Errors

Also, if desired, one can count the total number (octal) of Datamec words in each record. The results of these tests are displayed on the scope.

To assist the user in tape manipulation a backspace routine capable of backing over any number of records less than 7777<sub>8</sub> is included.

Four routines are included to check various aspects of Datamec operation.

1. Parity Test
2. Test-Record Generation
3. General Purpose Tape Checking
4. Test Record Verification

Computer: LINC

Title: General Sampling Program (GENSAM)

Author: Dean Hazelton, University of Wisconsin, Biomedical Computing Division, Madison, Wis.

This general-purpose program takes digitized samples from the LINC analog-to-digital converter and writes them on Datamec tape in a CDC compatible format. From one to four channels can be sampled with the time interval between samples variable at any multiple of one millisecond from 1 to 4095<sub>10</sub>. The individual channels are sampled almost simultaneously; with reference to the preceding channel, each succeeding channel is sampled 112  $\mu$ sec. later. Any of the LINC lines or potentiometers can be sampled. Starting and stopping can be effected by either a sense switch or a pulse on an external line. To assist the user in succeeding data manipulations, a sample counter is included which displays the total number of samples collected per channel.

## NEW DECUS MEMBERS

### PDP-4 DELEGATE

James E. Smith  
Chase Brass & Copper Company, Inc.  
Montpelier, Ohio

### PDP-5 DELEGATES

Donald R. Dubbert  
Denver Research Institute  
University of Denver  
Denver, Colorado

Thomas E. Wempe  
NASA Ames Research Center  
Mountain View, California

(Continued on Page 15)

# DECUS PROGRAM LIBRARY

DECUS No. 5/8-28(a)

Revised PAL III Modifications - Phoenix Assembler

Letter Received From Author Re: Modifications

"Dear Mrs. Cossette:

Enclosed is a binary tape and detailed instructions for our modified version of the PAL III assembler for the PDP 5/8. We feel this is a very useful program, and as such will be greatly appreciated by your users.

We have been operating with this assembler for five months, and have gotten all the bugs we found taken care of; however, due to the magnitude of the program it is at least probable that another user could turn up some other problem. Any such feedback can be referred directly to us.

This program should replace the previously submitted 'Pal III Modifications'; further, any user who has ordered that program should receive a copy of this one.

Sincerely,

Terrel L. Miedaner  
Phoenix Engineering and Computing  
Middleton, Wisconsin"

## PHOENIX ASSEMBLER

Users of the basic PDP-8 with Teletype I/O have probably found that the PAL III Assembler is slow and inefficient due to time consumed in reading the symbolic tape for each assembly pass. If the assembler is still being used, users are probably segmenting their programs into blocks of a page or so, thus, minimizing the read time in the event of program modifications to a small area. To eliminate this difficulty, the Phoenix Assembler, a modification of PAL III, has been developed.

Operation is essentially the same as PAL III, except that an additional pass has been added, Pass 0. This pass, started in the usual manner but with the switches set to zero, reads the symbolic tape into a core buffer area. Subsequent passes then read the tape image from storage instead of from the Teletype.

Pass 0 is terminated by a \$ appearing anywhere on the symbolic tape. The assembler will halt with the  $c(AC)=0$ ; Pass 1 may then be executed as usual but without the symbolic tape. If the tape overflows buffer storage, the computer stops with the  $c(AC)=77778$ . Either the tape or the symbol table must be shortened in this case, and the assembler must be restarted at address 0200.

Since the buffer area uses up the storage previously allotted to PAL's user symbol table, the Phoenix Assembler must restrict the size of this table. The binary tape supplied provides for 50 user defined symbols. Modification of the symbol table size by the user can be accom-

plished easily as follows: LOAD ADDRESS 0270; START; set the new table size into the switch register (in octal); CONTINUE. Restart the assembler at 0200. Note that if the permanent symbol table is redefined with the FIXTAB or FIXMRI pseudo instructions, it is necessary to redefine the user table also.

The speed increase is a factor of two over PAL. With a symbol table size of 50, the Phoenix Assembler will accept a tape with 4374 valid characters. This amounts to about 120 half-lines of Teletype printing, and has been found sufficient for the most liberally annotated programs. Users who are already segmenting their programs will find this useful; those who are not, may benefit considerably in throughput time by using this technique.

## PDP-5/8 PROGRAM LIBRARY ADDITIONS

DECUS No. 8-49

Title: Relativistic Dynamics

Author: G. Sharman, Southampton University, Southampton, Hampshire, England

Classification: Scientific Application

Minimum Hardware: PDP-8 (4K), ASR 33

Other Programs Needed: Floating Point Package C or D (DIG 8-5-S)

Source Language: PAL III

Storage Requirement: 65-713, 1000-1131, plus floating point

This program prints tables for relativistic particle collisions and decays in the same format as the Oxford Kinematic Tables. It can be used in two ways:

1. Two-particle Collisions - Given the masses of incident, target, and emitted particles, the incident energy and centre-of-mass angle, the program calculates angles and energies of the emitted particles in the LAB frame. If the process is forbidden energetically, program outputs "E" allowing the threshold energy to be found.
2. Single Particle Decays - By specifying  $M_2=0$  (target), the problem will be treated as a decay, and similar tables to the above will be printed.

DECUS No. 5/8-50

Title: Additions to Symbolic Tape Format Generator (DEC-8-21-U)

Author: Henry Burkhardt, Digital Equipment Corporation, Maynard, Massachusetts

Submitted by: Richard M. Merrill, DEC

The Format Generator can perform further useful functions by the addition of a few octal patches. By making the appropriate octal patches via the toggles, the Format Generator can also format FORTRAN tapes, shorten tape



by converting spaces to tabs, and convert the type of tape.

A short binary tape may be made and added onto the end of 8-21-U to "edit" an original tape that was punched off line.

The rubout character will cause successive deletion of the previous characters until the last C.R. is reached but not removed. The use of "←" will cause the current line to be restarted. Thus an input tape may be prepared off-line without attention to format spacings, mistakes corrected as they occur, and finally passed through the Format Generator to create a correctly formatted, edited, and line-fed tape on either rolled or fanfold paper tape.

#### DECUS No. 5/8-51

Title: Character Packing and Unpacking Routines

Author: Richard M. Merrill, Digital Equipment Corporation, Maynard, Massachusetts

ASCII characters may be packed two to a word and recovered. Control characters are also packable but are preceded by a 37 before being packed into the buffer. The two programs total 63<sub>10</sub> words.

#### DECUS No. 8-52

Title: Tiny Tape Editor

Author: Richard M. Merrill, Digital Equipment Corporation, Maynard, Massachusetts

This Tiny Tape Character Editor fits in core at the same time as the PAL III or MACRO-8 assemblers. A tape may be duplicated at three speeds and stopped at any character for insertion or deletion. The toggle switches control the speed and the functions desired.

The program occupies 72<sub>10</sub> registers.

#### DECUS No. 5/8-53

Title: COPCAT

Author: Russell Winslow\*, C. W. Adams Associates, Bedford, Massachusetts

COPCAT is a tape to tape copy routine for PDP-5 and PDP-8 DECTape.

\*This program was written while employed by DEC, Maynard.

### PDP-7 PROGRAM LIBRARY ADDITIONS

#### DECUS No. 7-25

Title: PDP-7/9 Dice Playing Program

Author: James Pitts, Digital Equipment Corporation, Maynard, Massachusetts

Equipment Needed: PDP-7/9, ASR 33

After the program has been loaded, a heading is typed and the program will request a bet. The player then types the amount of money in whole dollars, terminated by a CR. Striking "ALT MODE" key will simulate the rolling of the dice and the result will be printed on the teleprinter. A bet is always in whole dollars. The program ignores characters typed after a decimal point. The bet may not exceed \$9999.00. The first roll of the dice (Alt Mode key), determines the "point" (sum of the two dice). To win a roll, this "point" must be made again before the number seven on successive rolls of the dice. If, when determining the "point," a seven or eleven is rolled, the player wins that roll. Similarly, if the number two is rolled, the player loses.

A running total of the player's bets are tallied. If he wins more than \$9999.00, he wins the game and a new game is started. Similarly, if the player loses more than \$9999.00, he loses the game.

### LINC PROGRAM LIBRARY ADDITIONS

#### DECUS No. L-1

Title: Manuscript Compressed Print

Author: Alan C. Roachvarg, University of Wisconsin, Biomedical Computing Division, Madison, Wis.

MSCPNT is a program which prints LAP4 manuscripts (packed or unpacked) using the Teletype. The program is written to be used under GUIDE. Sense switch options and parameter input format are the same as those of MSPRNT. This routine is approximately 25% faster than MSPRNT.

The manuscript consists of three sections. The first is the main program, MSCPNT, which is 1622g lines long. The second part is the Q & A subroutine, Q+ASUB, which is 471g lines long. The third is the Teletype driver, TTYSUB, which is 204g lines long. The Q & A routine and TTYSUB are due to S. Davisson of Washington University, St. Louis, Missouri. The binary program requires six blocks of tape for storage under GUIDE. The program uses eight (8) quarters of memory at execution time.

#### DECUS No. L-2

Title: "Clock 1" for LINC; "Clock 8" for LINC-8

Author: James Davis, Digital Equipment Corporation, Maynard, Massachusetts

Classification: Demonstration

Minimum Hardware: LINC or LINC-8

Storage Requirement: 1K

"Clock 1" and "Clock 8" are demonstration programs for the LINC and LINC-8 respectively. The program also checks for the position of sense switch 0. If the switch is down, the clock runs normal (keeping time); switch up and the clock will run fast (not keeping time).

# NEW DECUS MEMBERS

## PDP-7 DELEGATES

Dr. Donald C. Eteson  
Worcester Polytechnic Institute  
Worcester, Massachusetts

Russell W. Ranshaw  
Department of Occupational Health  
University of Pittsburgh  
Pittsburgh, Pennsylvania

Theodore W. Tucker  
Concord Control, Inc.  
Boston, Massachusetts

## PDP-8 DELEGATES

Sergio F. Beltran  
National University of Mexico  
Mexico, D.F. Mexico

John D. Collins  
Raytheon Company  
Bedford, Massachusetts

Dieter Cordts  
Deutsches Elektronen-Synchrotron  
Hamburg, Germany

Glenn R. Elliott  
Sandia Corporation  
Albuquerque, New Mexico

Mr. Hermes  
Siemens-Reiniger-Werke AG  
Erlangen, West Germany

Dr. O.L.R. Jacobs  
Department of Electrical Engineering  
University of Edinburgh  
Edinburgh, Scotland

Dr. C.D. Lowenstein  
Scripps Institution of Oceanography  
Marine Physical Laboratory  
San Diego, California

Theodore Margolis  
United Aircraft Corp. System Center  
Farmington, Connecticut

W. I. McMillan  
Applied Electronics Laboratories of  
General Electric Company of England  
Portsmouth, Hants, England

## PDP-8 DELEGATES (Continued)

Christopher Nelson  
U. S. Public Health Service  
Northeastern Radiological  
Health Laboratory  
Winchester, Massachusetts

Edward P. Stabler  
Syracuse University, Hinds Hall  
Syracuse, New York

George R. Sugar  
Institute for Telecommunications  
Sciences and Aeronomy  
Boulder, Colorado

## PDP-8/S DELEGATES

H. G. Hoskins  
Wessex Engineering  
Chatswood, N.S.W. Australia

Christopher C. Pyne  
Baird Atomic, Inc.  
Systems Engineering X-Ray Department  
Cambridge, Massachusetts

Norbert H. Riegelhaupt  
Baird Atomic, Inc.  
Cambridge, Massachusetts

G. R. Symonds  
Department of Energy, Mines  
and Resources  
Topographical Survey Division  
Ottawa, Ontario, Canada

## LINC-8 DELEGATES

S. Buchet  
C. E. A.  
Paris 15<sup>e</sup>, France

Daniel G. Pace  
University of Pittsburgh  
School of Medicine  
Pittsburgh, Pennsylvania

Joseph B. Rotolo, Jr.  
Human Resources Center  
Albertson, New York

## INDIVIDUAL MEMBERS

Frank Alexander  
FMC Corporation  
Marcus Hook, Pennsylvania

Joseph P. Benson  
University of Pittsburgh  
Dept. of Occupational Health  
Pittsburgh, Pennsylvania

George I. Coats  
U. S. Public Health Service  
Northeastern Radiological  
Health Laboratory  
Winchester, Massachusetts

Ken De Muth  
United Aircraft Corporation  
Systems Center  
Farmington, Connecticut

Philip J. Erdelsky  
California Institute of Technology  
Pasadena, California

Robert Gilbert  
U. S. Steel Corporation  
Homestead, Pennsylvania

Russell B. Ham  
U. S. Public Health Service  
Northeastern Radiological  
Health Laboratory  
Winchester, Massachusetts

Richard A. Hunt  
Nuclear Physics Group  
Oxford University  
Oxford, England

John R. Kosorok  
Battelle-Northwest  
Richland, Washington

J. C. Murray (Mrs.)  
Department of Nuclear Physics  
Oxford University  
Oxford, England

Matthew Pernick  
New York University  
Brooklyn, New York

INDIVIDUAL MEMBERS (Continued)

John Ritz  
Rome Air Development Center-Ebase  
Rome, New York

Lloyd B. Robinson  
University of California  
Lawrence Radiation Laboratory  
Berkeley, California

Triston J. Rosenberger  
University of California  
Berkeley, California

Donald A. Roy  
Nova Scotia Technical College  
Nova Scotia, Canada

Theodore R. Sarbin, Jr.  
University of California  
Berkeley, California

Leonard Shalit  
Northern Electric  
Montreal, Quebec, Canada

John J. Sharp  
Standard Telephones and Cables Ltd.  
Barnet, Herts, England

L. Thomas Sheffield  
University of Alabama  
Birmingham, Alabama

Dr. Richard B. Shepard  
University of Alabama Medical Center  
Birmingham, Alabama

G. C. Shering  
University of Edinburgh  
Department of Electrical Engineering  
Edinburgh, Scotland

M. A. Skinner  
General Electric Company Ltd.  
Portsmouth, Hampshire, England

Thomas P. Skinner  
M.I.T. Project MAC  
Cambridge, Massachusetts

Lyall V. Smith  
Atomic Energy of Canada, Ltd.  
Chalk River, Ontario, Canada

Andrew Spear  
University of Alabama  
Birmingham, Alabama

INDIVIDUAL MEMBERS (Continued)

Robert T. Spittler  
Chase Brass & Copper Company, Inc.  
Montpelier, Ohio

Dr. Ralph W. Stacy  
University of North Carolina  
Chapel Hill, North Carolina

Dr. Lawrence Stark  
Presbyterian - St. Luke's Hospital  
Chicago, Illinois

John J. Stolzenhaller  
United Aircraft Research Laboratories  
East Hartford, Connecticut

H. Wayne Swafford  
Wheeling Steel Corporation  
Steubenville, Ohio

R. L. Swenson  
Lawrence Radiation Laboratory  
Livermore, California

David Roy Thompson  
Whiteshell Nuclear Research Est.  
Pinawa, Manitoba, Canada

William B. Truitt  
National Bureau of Standards  
Washington, D. C.

Chiyeko Tsuchitani  
University of Pittsburgh  
Pittsburgh, Pennsylvania

Martin Vangerov  
Associated Aerospace Laboratories  
East Pasadena, California

Mary Ann Wall  
Northeastern Radiological Health Laboratory  
Winchester, Massachusetts

Gerhard Werner, M.D.  
University of Pittsburgh  
Department of Pharmacology  
Pittsburgh, Pennsylvania

William R. Wetzel  
15 Cortland Street  
Milltown, New Jersey

William Roger Bryan Willis  
Digital Equipment Corporation (UK) Ltd.  
Reading, Berkshire, England

INDIVIDUAL MEMBERS (Continued)

J. Walter Woodbury  
University of Washington  
Seattle, Washington

J. R. Wormald  
University of Liverpool  
Liverpool 3, England

Ronald Zane  
Lawrence Radiation Laboratory  
Berkeley, California

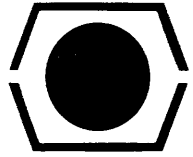

V5 N 10

# "LETTERS"

Letters of general interest will be published as a standard insert to each issue of DECUSCOPE. Letters written between users, to DEC personnel, and to the DECUS office will be included. Submissions to this section, "Letters Insert," should be sent to: Angela J. Cossette, DECUS Executive Secretary, DECUS, Maynard, Massachusetts 01754.

DIGITAL EQUIPMENT COMPUTER USERS SOCIETY

UNIVERSITY OF OXFORD DEPARTMENT OF NUCLEAR PHYSICS

*Nuclear Physics Laboratory, 21 Banbury Road, Oxford.*

*Telephone 54141*

8th November, 1966.

Mrs. A. J. Cossette,  
Digital Equipment Computer Users Society,  
Maynard,  
Massachusetts, U.S.A.

Dear Mrs. Cossette,

We have recently concluded our Autumn Decus meeting. As a result it was agreed that we ask the present Decus executive board to accept the European committee as a standing committee. The European Decus Committee is to consist of Chairman, Vice-Chairman, Paper Secretary, Accommodation Secretary and Proceeding Secretary. They will be elected at each meeting for the organisation of the one following. One member from the preceeding committee to be coopted to the new one.

Meetings in Europe are to be once a year. Decus in Europe would expect to use the existing Decus by laws in their entirety.

Yours sincerely,



(pp) Decus Committee Europe

H. Karl Vice-Chairman  
B. Macefield Chairman



PACIFIC NORTHWEST LABORATORIES a division of BATTELLE MEMORIAL INSTITUTE

PACIFIC NORTHWEST LABORATORY

P. O. Box 999 Richland, Washington 99352

Telephone: Area Code 509, 942-1111, Ext. 6-5400

Cable Address: BATNORLAB

November 15, 1966

Mrs. Angela Cossette  
DECUS Executive Secretary  
Digital Equipment Corporation  
146 Main Street  
Maynard, Massachusetts 01754

Dear Mrs. Cossette:

Here is the letter you ask for during the 1966 Fall DECUS meeting. It seems to me that at the rate DECUS is expanding, some tutorial papers would help the newcomer and also inspire the experienced programmer to communicate with the outside world. I feel one tutorial paper per day (or two per meeting) would serve the existing need. Listed below are a few fruitful areas I would like to see presented at the assembly language level (if possible).

1. Development of simple arithmetic programs in:
  - a. Matrix inversion
  - b. Integrations
  - c. Sin, tan, target, etc.
  - d. Log X,  $e^x$
  - e. Square root, variable roots, etc.
  - f. Process control algorithms
    1. Feed forward
    2. Feed back 2 & 3 mode controllers
    3. Adaptive control
2. Principles of compilers
3. Principles of interpreters
4. Principle of FORTRAN monitor
5. Principles of off-line compilers for debugging PDP- service programs on larger machine. (I understand Argonne National Laboratories have one such program for debugging PDP-7 programs on a CDC 3600.)
6. Basis of time shared programs pointing out pitfalls, tricks, etc.

I realize this is a big request, but I also realize that there is a mammoth training job required to educate the people required to fulfill

Mrs. Angela Cossette

2

November 15, 1966

the dreams and expectations of time-shared and direct digital control systems.  
The DEC programming manuals are not enough.

Easily read and easily learned written material on the subject is needed.  
Can DECUS help?

Very truly yours,

A handwritten signature in cursive script that reads "R D Benham". The letters are fluid and connected, with a prominent "R" and "B".

R. D. Benham, Manager  
Systems Analysis and Simulation

RDB/lsr

P. S. If you would like an outside opinion or review of tutorial papers,  
we, at Battelle, are available.



**digital** EQUIPMENT  
OF CANADA LTD.

P.O. BOX 370 . CARLETON PLACE, ONT.

PHONE

237-0772

AREA CODE 613

(DIRECT OTTAWA LINE)

Dear *Angela*,

Recently, the DECUS organization associated with Digital sponsored a symposium which was attended by representatives of the twenty (20) major computer users groups. We are very pleased to report that DECUS rated second only to IBM in the number of meetings, number of publications, size of the user's library, etc. Needless to say, this was pleasant information for Digital.

We in Canada have been applauded by the DECUS society for the number and quality of papers given by Canadian users at the DECUS meetings. The contributors are to be congratulated. Paradoxically, it has been pointed out that there are very few programs in the DECUS software library from Canadian users.

On the scale of the whole user's group, the "Pain" associated with checking out and documenting programs seems to be the major obstacle in contributions to the DECUS Library. Therefore, to alleviate this pain, the Canadian company proposes, on an experimental basis to:

- take the responsibility of receiving write-ups, symbolic listings and symbolic tapes
- perform final check-out and documentation functions for the users
- forward these programs to DECUS



The programs in which DECUS is especially interested include:

- Special I/O Utility Programs (all peripheral devices especially X-Y plotters and incremental plotter routines)
- Code conversion programs
- Program conversion programs (PDP-1 to PDP-4/7/9, PDP-4 to PDP-5/8, etc.)
- Relocatable or other special loaders
- Special arithmetic routines (single and double precision, high speed multiply/divide especially)
- Auto and Cross-Correlation programs
- Signal Processing Programs
- Data Acquisition Programs
- Teaching Programs
- Demonstration Programs

In addition, FORTRAN programs of any type would be appreciated. If you would be willing to participate in this experiment, please let me know. It is the hope of the Canadian company that we will become one of the most active supporters of DECUS by the implementation of this joint effort.

Finally, it is the hope of Digital Equipment of Canada to sponsor a regional DECUS meeting somewhere in the area of Ottawa. If you would be willing to attend and/or give a paper, please fill out the enclosed information sheet.

Yours sincerely,



J.E. Richardson,  
Applications Programmer

JER:jp

PROPOSED REGIONAL DECUS MEETING

CARLETON PLACE, ONTARIO

Winter 1966-67

- ( ) I would be eager to attend a regional DECUS meeting in Carleton Place during the winter of 1966-67.
- ( ) I would be willing to give a paper(s) at this meeting.
- ( ) I would enjoy hearing papers presented on module applications as well as computer applications.
- ( ) Other \_\_\_\_\_  
\_\_\_\_\_  
\_\_\_\_\_

Signed: \_\_\_\_\_

Employer: \_\_\_\_\_



22 November 1966

DECUS Executive Secretary  
Digital Equipment Computer Users Society  
Maynard, Massachusetts 01754

Dear Sir:

I am enclosing two applications for installation membership for a PDP-7 that has been installed for sometime, but whose present delegate, Mr. George Torrero, is no longer involved with its application or use, and a PDP-9 which is due to be delivered between January and April of 1967.

During the past year we have developed for the PDP-7, a non-FORTRAN Dectape handling system, which we have found very useful in our specific application. There was some interest generated in the Dectape System by a Mr. Philip Williger, one of the sales personnel of DEC at the Anaheim Office. He seemed to indicate the need for such a system in other applications and as part of the main software line of the company.

The Dectape System provides easy access from Dectape of the Assembler, Editor and DDT. It also has the capability to store additional programs on tape with relative ease.

Therefore, I am enclosing a copy of the write-up of the system to you for further consideration and approval as to its usefulness in other areas and as part of the software line.

There are two systems indicated in the write-up. Dectape System 1 is the one that would be of most interest to you.

In another area of our work the need arose to link a FORTRAN program with a machine language subroutine. We found no explicit explanation of how this can be accomplished in the manuals. However, after numerous and frustrating hours we came up with a way.

I wrote this method up and I am also enclosing that paper. Perhaps it may be of use to other users in the same situation. But, if there is an easier sure-fire way someone else developed, I would appreciate being informed of such a procedure.

In conclusion, I am looking forward to being an installation member, and I hope to hear from you soon.

If there are any questions concerning the papers enclosed, please contact me.

Sincerely,

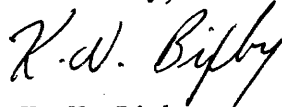
A handwritten signature in cursive script that reads "K. W. Bixby". The signature is written in dark ink and is positioned above the typed name and title.

K. W. Bixby  
Engineer

KWB:bh  
Enclosures